

SOCCER GOALKEEPING



Print & Go Practice Plans and Drills

intermediate & advanced skills & tactics

an essential guide for all soccer coaches

World Cup 2010 (2nd) Edition

written by best selling soccer author Tom Sauder

TABLE OF CONTENTS

Acknowledgement	4
Introduction	5
Our Philosophy	6
Usage Recommendations	7
Practices Summary Matrix	8
Season Practice Sequences	9
<u>Print & Go Practice Plans</u>	10
# 1 Catching, Diving, Breakaways, Distribution	11
# 2 Reaction, Flexibility, Diving, Wall	12
# 3 Diving, Jumping, Corners, 1v1	13
# 4 Jumping, Diving, Abdominals, Pass Backs	14
# 5 Strength, High Balls, Goal Kicks, Reading Play	15
# 6 Ball Handling, Leg Strength, Dives, Crosses	16
# 7 Reflex Dives, Leg Strength, Distribution	17
# 8 Agility, Change of Direction Dives, Penalties	18
# 9 Continuous Diving, reaction, Organizing Play	19
#10 Catching, Back Dives, Angles, Long Balls	20
<u>Warm Ups</u>	21
# 1 Catching, Diving	22
# 2 Flexibility, Coordination	23
# 3 Coordination, Catching	24
# 4 Jumping, Abdominal Strength	25
# 5 Jumping, Flexibility	26
# 6 Ball Handling, Reaction	27
# 7 Leg Strength, Catching	28
# 8 Agility, Catching, Recovery	29
# 9 Catching, Jumping, Diving	30
#10 Catching, Running, Passing	31
<u>Technique Drills</u>	32
# 1 Diving, Distribution	33
# 2 Reaction Dives	34
# 3 Jumping, Diving	35
# 4 Backward Dives	36
# 5 Diving after Motion	37
# 6 Turn & dive, Bouncing Balls	38
# 7 Reflex Dives	39
# 8 Change Direction & Dive	40
# 9 Continuous saves	41
#10 Diagonal Backward Dives	42

TABLE OF CONTENTS

<u>Fitness Drills</u>	43
· # 1 Diving, Recovering	44
· # 2 Circle Dives	45
· # 3 Jump from lying position	46
· # 4 Jumping and Diving	47
· # 5 Run-Jump-Crouch-Throw	48
· # 6 Sideways Hops and Dive	49
· # 7 Sprint-Jump-Dive	50
· # 8 Balance-Sprint-Dive	51
· # 9 Triple Dive-Recovery-Dive	52
· #10 Rapid Fire	53
<u>Tactical Drills</u>	54
· # 1 Brakaways	55
· # 2 Setting Up a Wall	56
· # 3 Corner Kicks	57
· # 4 Pass Backs	58
· # 5 Goal Kicks	59
· # 6 Crosses	60
· # 7 Wide Distribution Throws	61
· # 8 Penalty Kicks	62
· # 9 Organizing Play	63
· #10 Long Balls - Incoming	64
<u>Scrimmages</u>	65
· # 1 4v4 from two sides of goal	66
· # 2 4v2 in penalty area	67
· # 3 4v2 or 1v1	68
· # 4 3v3 on two goals	69
· # 5 3v3 with 2 balls	70
· # 6 crossing and 4v2 in penalty box	71
· # 7 4 x 1v1 in penalty box	72
· # 8 GK in 1v1	73
· # 9 4v6	74
· #10 2v5 in penalty box	75

ACKNOWLEDGEMENTS

This book is dedicated to all coaches, players, parents and officials without whose passion for soccer the greatest game in the world could not exist.

We thank all the teams, goalkeepers, players and coaches that have participated in developing the practice sessions and used them on the field to make sure they work.

Introduction

The idea for Print & Go practices came from a recognition that something was missing for soccer coaches amongst all the training materials and resources available.

You probably have books and videos full of soccer drills and practice ideas.

But what about soccer goalkeeping drills and practice plans? Most coaches have played the game and can pull something together for a regular team practice. However, few coaches have been goalkeepers. Quite often, during team practices, goalkeepers are left to themselves, have someone take shots or they participate in regular drills. Rarely do teams have specialized goalkeeper coaches. Whether you do or not, we thought to help you out by developing complete practice plans for your goalkeeper.

We have pulled together a series of drills covering all aspects of soccer goalkeeping and combined them into challenging and exciting practice sessions. The drills are explained in a way that you do not need to be a goalkeeper to run them. However, if you have goalkeeping experience, you will be able to add to the practice using your skills.

There are several advantages to using special goalkeeper practices during your team practice or on separate occasions:

- “ Your goalkeepers will get better, without a doubt. Our practices are designed to develop all physical, skill, tactical and mental aspects of goalkeeping.
- “ Your goalkeepers will feel special, because someone is actually recognizing them as a distinct, yet important contributor to the team.
- “ Your goalkeeper will gain confidence.
- “ Your team will gain confidence.
- “ Your goals against will go down and your success will increase.

Our (and now your) practices are designed for goalkeepers who have some basic understanding of the position and who are interested to improve their skill.

This book is not about teaching the very basics such as hand position, “ready position”, and precise diving technique. There are resources for that, such as goalkeeping clinics, websites and books. This book is about having the drills and practices to take your goalkeeper to the next level.

We supplement the printed material in this book by pictures of stretches and basic techniques on our website www.soccerpracticebooks.com.

We recommend this book for ages 11 and up including High School and College teams.

These practices and drills have been run with 10-12 year old boys' teams; 14-16 year old girls' teams and College teams. We hope you will enjoy your season.

Our Philosophy

Practices need to be fun for players and coaches. Drills must be interesting and vary across skills, tactics, strategies, mental and physical fitness and team building.

Keepers need to be busy with a ball at all times to maximize the number of touches they get with the ball.

Practices must flow and time must not be wasted by the coach setting up or thinking about drills.

Practices and drills must have a purpose.

Goalkeepers require somewhat special attention as their job is difficult and can be thankless. A goalkeeping mistake can cost the team a game, while every other player's mistake will likely never be remembered. This responsibility puts special pressure on the keeper and requires a particular focus and mental toughness, while at the same time being calm and relaxed to deal with game situations.

We suggest you dedicate an assistant coach or a volunteer parent or friend to work with your goalkeeper(s) during regular practice. This allows you to coordinate the keeper drills with those of team since some of the goalkeeper exercises require other players. You can also modify the scrimmage drills to fit in with the drills you are running for the team. Alternatively you can insert your goalkeepers into suitable drills, being careful that they receive the same level of specific instruction as does the team. Ideally, you would have a goalkeeper coach who can not only work with the keeper, but who will build the ever important relationship with the goalkeeper and who can focus on developing the "right mindset" for your keeper.

You can also schedule separate goalkeeper practices. Be aware of the drills that require field players and either modify them or recruit volunteers to play these roles. You can also mix and match the drills to suit the number of support players you will have available.

We suggest that each practice starts with a brief meeting between coach and keeper(s) in which the theme of the practice is communicated.

Then start with a warm up. You will notice that our warm-ups already incorporate the theme of the practice, lots of ball work, fitness and thinking exercises in a purely goalkeeping way. No repetitive running, not many exercises without a ball and if so, then they are fun and challenging.

We have cushioned the fitness section between technical and tactical drills. The reason is that we want keepers to be properly warmed up for skill work, but then challenge their stamina and mind by requiring technical skills after fitness work.

End with a scrimmage and feel free to adapt them or change them to fit in with your team's needs.

After the practice, have a quick meeting again for going over the practice briefly, invite comments from the keeper(s), congratulate them on their effort and improvement and give them encouragement and a specific focus for the next game.

During the drills, be patient. Observe and intervene only when needed. Keep your comments positive, to the point and brief. Speak loudly and clearly. It is better to demonstrate a drill or a concept than to

give a speech. Never yell at a player or use derogatory language. If you are not a goalkeeping expert, look at the results and discuss with the goalkeeper how he/she would improve performance. Chances are they know. If they don't, recruit someone you know and who knows goalkeeping for input.

Usage Recommendations

We have developed a matrix for the 10 sessions showing the focus of the practice and of each of the drills in the practice. Please study the matrix to become familiar with the content of each session and drill.

There is a page suggesting various ways to sequence these sessions. Chose the emphasis for your next 10 practices (which could be a season or pre-season) and study the sequence suggested. Of course, you are free to develop your own sequence. Refer to the individual practice sheets or the individual PracticeBuilder drill sheets for a better understanding. Write comments on the drill sheets.

We suggest you visualize the drills to make sure you understand how they will flow. If necessary, set them up in your living room and walk through them.

Keep a clean copy of the book at home and put the pages you take to the practice with you in clear plastic sheet protectors to protect them from water or other disturbances (you know what can happen to papers).

You can design your own practices. If your keeper needs 4 technical sessions and no tactical work, go for it.

This book is provided or sold on an as is basis without warranties of any kind, express or implied, including but not limited to those of title, merchantability, fitness for a particular purpose, or non infringement, or any warranty arising from a course of dealing, usage, or trade practice. The user assumes all responsibility or risk for the use of this practice book and the drills. contained therein. Under no circumstances, including negligence, shall any of the parties involved in creating, maintaining, or supplying information used in this practice book and the drills contained therein be liable for any direct, indirect, incidental, special, or consequential damages, or lost profits that result from the use or inability to use this soccer practice book and its soccer drills.

Practice #	Practice Focus	Warm-Up Focus	Technical Drill	Fitness Focus	Tactical Drill	Scrimmage Focus
1	Catching Diving Breakaways Distribution	Catching Diving	Diving Distribution	Diving Recovering	Breakaways	4v4 from two sides of goal
2	Reaction Flexibility Diving Wall	Flexibility Coordination	Reaction Dives	Circle Dives	Setting up a Wall	4v2 in penalty area
3	Diving Jumping Corners 1v1	Coordination Catching	Jumping Diving	Jump from lying position	Corner Kicks	4v2 or 1v1
4	Jumping Diving Abdominals Pass Backs	Jumping Abdominals	Backward Dives	Jumping & diving	Pass Backs	3v3 on 2 goals
5	Strength High Balls Goal Kicks Reading Play	Jumping Flexibility	Diving after Motion	Run-Jump- Crouch-Throw	Goal Kicks	3v3 with 2 balls
6	Ball Handling Leg Strength Dives Crosses	Ball Handling Reaction	Turn & Dive Bouncing Balls	Sideway Hops & Dive	Crosses	Crossing and 4v2 in penalty box
7	Reflex Dives Leg Strength Distribution	Leg Strength Catching	Reflex Dives	Sprint-Jump-Dive	Wide Distribution Throws	4 times 1v1 in penalty box
8	Agility Change of Direction Dives Penalty Kicks	Agility Catching Recovery	Change Direction & Dive	Balance-Sprint- Dive	Penalty Kicks	GK in 1v1
9	Diving Reaction Organizing Play	Catching Jumping Diving	Continuous Saves	Triple Dive- Recovery-Dive	Organizing Play	4v6
10	Catching Backward Dives Angles Long Balls	Catching Running Passing Long Balls	Diagonal Backward Dives	Rapid Fire	Long Balls	2v5 in penalty box

Practice Sequence Suggestions

Coaching Emphasis

Practice Sequence

Catching

1-6-5-2-7-8-9-3-10-4

Diving

7-8-9-6-1-4-2-5-10-3

Recovering

1-7-9-10-8-5-4-2-3-6

Jumping

3-5-6-4-2-1-7-8-9-10

Reaction & Reflex

9-8-7-5-10-4-2-6-1-3

Distribution

10-9-7-1-3-4-5-8-2-6

Leg Strength

5-4-6-3-2-9-1-7-8-10

Angles

2-3-1-4-5-7-10-6-9-8

Agility

3-2-8-1-10-4-5-6-7-9

Goalkeeping

Practice Plans



SOCCKER GOALKEEPING PRACTICE # 1

Practice Focus: Catching, Diving, Breakaways, Distribution

Time: 1.5 hrs

Warm-Up: Catching, Diving

1. Shuttle Run/Stretch #1

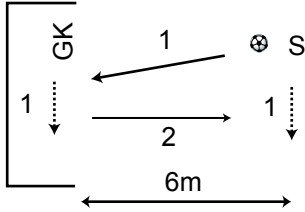

1. While GK & S sidestep across goal, S throws ball to GK. (above head, chest high, ground)
2. GK catches/picks up ball and throws it straight back to S.
3. Shuttle back and forth across goal 6 times.

2. Sit and Catch/Stretch # 2

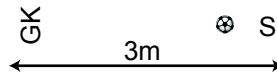

GK sits with legs apart. S throws ball at GK, changing pace of throws. GK catches, recovers to sitting position and throws ball back. Extend GK to fall backwards and sideways.

3. Kneel and Catch/Stretch #3

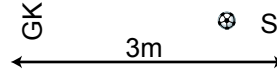

GK on knees. S throws ball as in exercise 2 above. GK catches, recovers, throws ball back

Stretch # 1: Upper Body

- GK stands, legs shoulder width apart.
- GK holds ball with both hands, arms straight and extended back over head, - 20 secs.
 - GK holds ball straight out front - 20 sec.
 - GK, knees slightly bent, holds ball and pushes arms back between legs - 3 sets

Stretch # 2: Hamstrings

GK sits with legs apart, holding ball with both hands. GK extends arms to hold ball over right foot - holds 20 sec. Alternates holding ball over each foot three times.

Stretch # 3: Shoulders

GK stands 2 steps beside goal post extending arm near post above head leaning against post. Hold each arm 20 secs, 3 repeats.

Technique: Diving, Distribution

Crouch & Dive

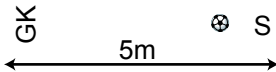

GK is in crouching position. S throws high balls left and right. GK dives and catches. Increase difficulty as appropriate

Dive & Distribute

1. S throws low ball to GK right.
 2. GK dives, saves, recovers and throws ball to A. GK returns to center of goal.
 3. S throws high ball to GK left.
 4. GK dives, saves, recovers and throws ball to B.
- Repeat

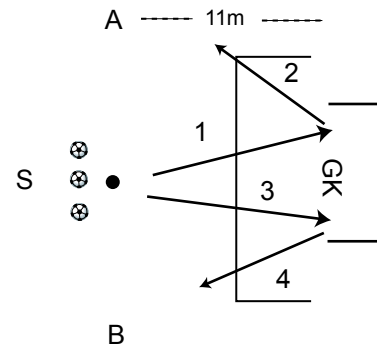

Fitness: Diving, Recovering

Two GK work together.

1. GK A rolls ball to left of GK B
 2. GK B dives, catches ball, gets up and
 3. throws to GK A,
 4. who has moved straight across GK B.
- Repeat across the width of the field. Coming back GK B rolls and GK A dives. Repeat twice for each GK making sure they dive to their left and their right side.

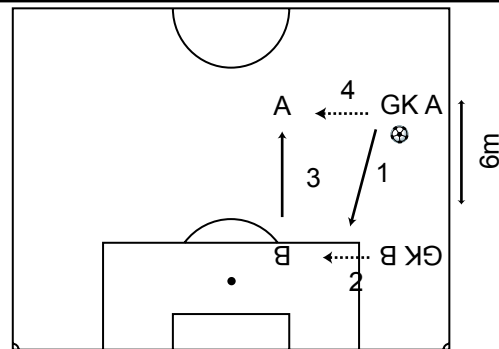

Tactical: Breakaways

A, B, C take turns dribbling on goal. GK starting position is 3m off goal line. GK waits until attackers are at top of penalty box. GK then comes out in a crouching position cutting attackers angle to goal. GK keeps eyes on ball and gets in "set" position between the 6yd box and penalty spot. GK waits for move and dives at ball at attackers feet or saves a shot.

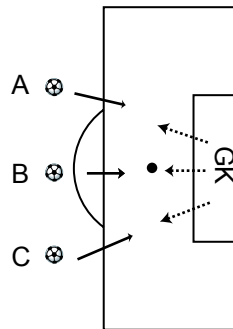

Scrimmage: 4v4 from two Sides of Goal

X play 4v4 against O
Teams can score from either side of goal.
Emphasize quick passing and shots as well as quick switches to other side of goal forcing GK to turn around quickly and get set for new shot from new angle.

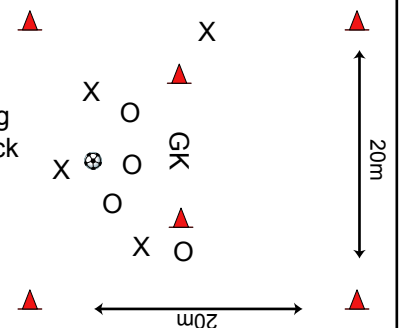



SOCCER GOALKEEPING PRACTICE # 2

Practice Focus: Reaction, Flexibility, Diving, Wall

Time: 1.5 hrs

Warm-Up: Flexibility, Coordination

- GK sits with legs apart, holding ball in front. GK tosses ball straight up, lifts both legs, moves hands under legs and catches ball. Repeat and challenge GK by reducing height of toss.
- Upper Body Stretch
- GK walks while holding ball straight out. Alternately move right foot and left foot up to ball, touching ball with laces. Walk from goal line to top of penalty box and back three times.
- Hamstring Stretch
- Repeat exercise # 3 while jogging slowly.
- Shoulder Stretch
- Coach rolls, throws (low - knee high; mid - stomach high; high -chest/head; above head) ball to goalkeeper from various angles and distances starting at the penalty spot. GK catches ball and throws it back to coach. Allow GK time to recover and reset in proper "ready" position.

Technique: Reaction Dives

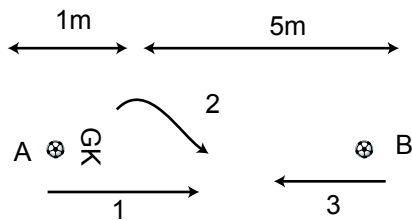

GK faces A with legs apart in the crouching 'ready' position.

- A rolls ball through GK legs.
- GK turns and dives to save ball, then recovers and gets up into ready position as quickly as possible.
- While GK is recovering, B throws a high ball to the opposite side for a diving save by GK.

A and B time their throws to keep GK in motion while allowing recovery time.

Fitness: Circle Dives

GK is in the center of a circle made with 8 balls. Each ball is 6m away from the center.

- GK dives to each ball, touching it with the leading hand, i.e. GK dives to the left - touches ball with left hand.
- GK recovers to center, gets in ready position (low crouch) and dives to each ball. Reverse direction of dive for the second round.

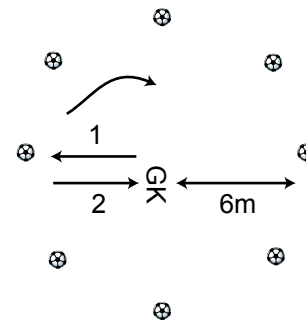

Make sure that the playing surface is soft and GK has protective padding. Not recommended for hard ground.

Tactical: Setting Up a Wall

- GK stands at near post and looks in a straight line at ball. GK directs wall such that the outside player is in line with ball, just blocking GK view of ball.
- GK then moves towards far post until GK sees ball around inside player of wall.

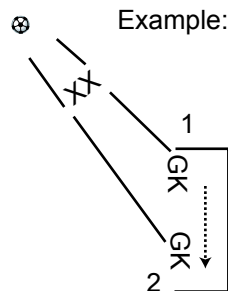

Scrimmage: 4v2 in Penalty Area

GK starts play by throwing a ball to an attacker (X).

X must get players into shooting positions quickly and take shots from any angle and distance.

Have balls available for GK to restart play quickly after a shot.

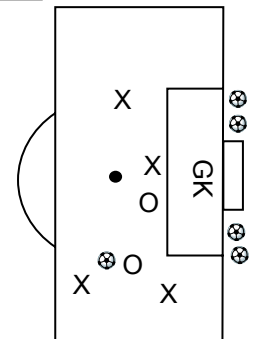



SOCCER GOALKEEPING PRACTICE # 3

Practice Focus: Diving, Jumping, Corners, 1v1

Time: 1.5 hrs

Warm-Up: Coordination, Catching

1. GK runs from goal line to the top of the penalty box and back. While running, GK tosses ball with right hand over the head (sideways) and catches it with the left hand. GK then throws with left hand and catches with the right. Repeat twice from goal line to top of box and back.
2. Upper Body Stretch
3. GK stands with legs apart, knees slightly bent, and holds ball behind the head. GK drops ball and quickly moves hands through legs to catch the falling ball (behind the back).
4. Hamstring Stretch
5. GK lies on stomach holding ball in hands with arms extended straight ahead. GK throws ball straight into the air, rotates quickly to lie on their back, and catches ball.
6. Shoulder Stretch
7. GK is two steps off the goal line. Coach throws a ball from the penalty spot on goal, over GK head. GK jumps and tips ball with the fingers over the cross bar of the goal.

Technique: Jumping, Diving

Jumping:

1. GK stands one step off the goal line in a crouched position.
2. Coach (C) throws high ball over GK head.
3. GK jumps up and deflects ball over cross bar or catches it.

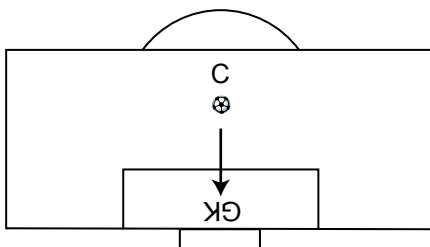

Diving:

1. GK stands with legs apart and holds ball at the right foot.
2. GK rolls ball back through legs, turns (pivots) and dives back to grab ball with both hands.
3. Alternate right and left.

Fitness: Jump from Laying Position

1. GK lies on stomach facing the goal, head at the top of the 6yd box.
2. Coach (C) is behind the goal and throws a high, arcing, ball over top of the cross bar towards the GK.
3. GK jumps up and catches the ball at its highest point.
4. After catching the ball and before getting feet back on the ground, GK throws ball back across the goal to the coach.

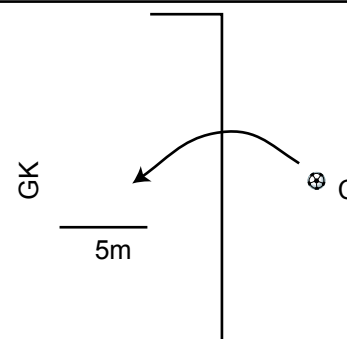

Focus on catching the ball before attempting to throw it back in the same motion.

Tactical: Corner Kicks

1. GK stands 2-3 steps off the goal line.
2. GK is positioned between center of goal and 3/4 way to far post.
3. GK positions defenders at posts and to mark attackers.
4. If GK has clear path to ball, GK attacks ball, jumps with one knee up to catch ball or punch it out with one or both fists.
5. If GK has no path to the ball, GK plays angle to ball and prepares to make a save.

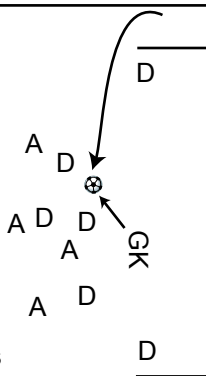

Scrimmage: 4v2 or 1v1

X play 4v2 against O outside the penalty box. ▲

X set up a shot from outside or pass the ball into the area to another X making a run to play 1v1 on GK.

Encourage lots of shots and mix with 1v1. ▲

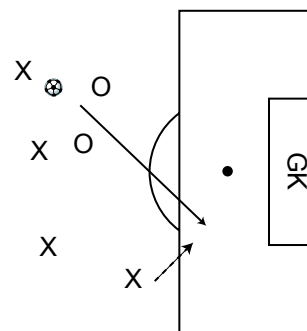



SOCCKER GOALKEEPING PRACTICE # 4

Practice Focus: Jumping, Diving, Abdominals, Pass Backs

Time: 1.5 hrs

Warm-Up: Jumping, Abdominals

1. Jumping

- GK faces hurdle or obstacle.
- GK jumps over hurdle and makes 1/2 turn in the air.
- GK lands on other side facing hurdle.

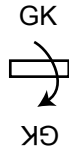

2. Upper Body Stretch

3. Abdominal Strength 1

- GK lies on back holding ball with both hands, arms extended all the way behind the head.
- GK rotates one complete turn holding on to the ball. When lying on back again, GK brings ball to the laces of both shoes while pulling both knees towards the chest.

4. Hamstring Stretch.

5. Abdominal Strength 2

- Two goalkeepers work as partners.
- GK 1 stands and holds a ball next to their right hip.
- GK 2 lies on the side away from GK 1 with both feet locked between GK 1's feet to prevent sliding.
- GK 2 now lifts upper body and touches the ball held by GK 1 with both hands.
- Do 4 sets of 10 for each GK, alternating side GK lies on.

6. Shoulder Stretch

7. Rapid Shooting

4-6 players line up at the top of the penalty box and take shots, giving GK enough time between shots to 'reset'.

Technique: Backward Dives

Coach stands inside post with ball.
GK stands with back to goal, 3-4 m in front of goal.

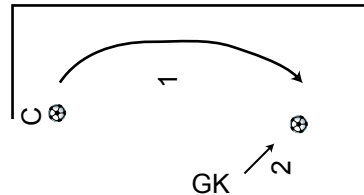

1. Coach throws ball in a high arc across goal line, giving verbal signal to GK when ball is thrown.
2. GK looks over shoulder and dives backwards to catch ball.

Fitness: Jumping & Diving

1. GK runs across hurdles and:
 - a. dives over last hurdle, turning on side in air,
 - b. jumps over last hurdle, rotates in air to land facing coach (C), then dives,
 - c. jumps over last hurdle, jumps backward over same hurdle, then dives again over the hurdle, turning on side in air
 2. catch the ball thrown by coach with two hands.
- Repeat (a)-(c) five times.

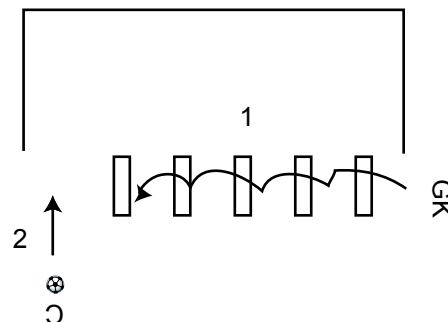

Tactical: Pass Backs

1. From center of field, D plays ball to GK stronger foot (right is shown) to side of goal.
2. Once GK knows where ball is going, GK quickly moves to receive ball.
3. Without pressure, GK can play ball long or pass it on 2nd or 3rd touch. GK then returns to center of goal.

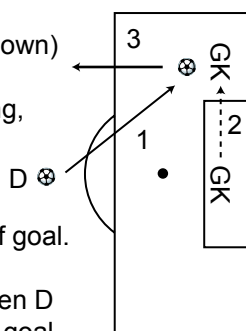

If D has ball on either side of field, then D plays it straight back to same side of goal

Scrimmage: 3v3 on Two Goals

Make two 3m wide goals adjacent to each other in the corner of the field.

One GK covers both goals.

X and O can score on either goal.

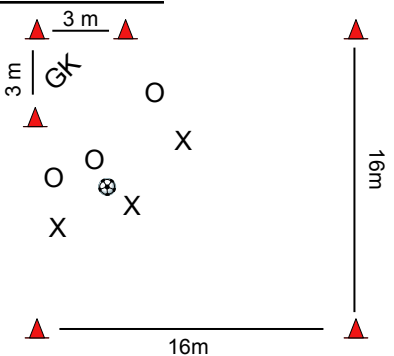



SOCCER GOALKEEPING PRACTICE # 5

Practice Focus: Strength, High Balls, Goal Kicks, Reading Play

Time: 1.5 hrs

Warm-Up: Jumping, Flexibility

1. Jumping

- throw ball high over GK head.
- GK jumps up, timing the catch of the ball at it's highest point.
- while reaching for the ball, GK pulls one knee up towards chest.

2. Upper Body Stretch

3. Catching

- throw a ball from 5m away toward GK chest.
- GK jumps just high enough for ball to meet GK's body at the pectoral muscles.
- GK bends arms and cradles ball into chest.

4. Hamstring Stretch.

5. Flexibility

- Two goalkeepers work as partners.
- They lie on stomach facing each other with a hurdle or other obstacle in between them.
- GKs throw ball to each other across the hurdle.
- GKs catch ball with two hands, raising upper body off the ground as much as they comfortable can.



6. Shoulder Stretch

7. Catching under Pressure

coach throws high ball from the top of the penalty box. One forward goes for a header. GK challenges to catch ball.

Technique: Diving after Motion

1. Double Jump Dives

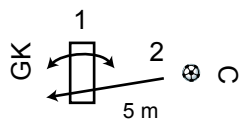

1. GK jumps forwards and backwards across a hurdle.
2. As GK lands after jumping backwards, coach throws a ball for a diving save.

2. Somersault & Dive

1. GK starts on goal line facing coach (C) and makes a somersault (roll) forward.
2. As GK comes up out of the roll, coach shoots from the top of the box. GK quickly sets and makes diving save.

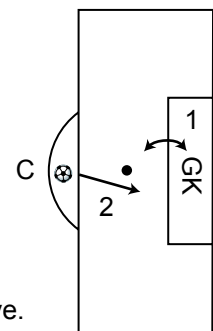

Fitness: Run - Jump - Crouch - Throw

1. Coach throws ball in a high arc from behind the net over top of cross bar. The ball should be aimed to come down between the 6 yd box and the penalty spot.
2. The GK waits for the throw at the top of the 18 yd box. When the ball is thrown, GK runs towards it and jumps high to catch ball at it's highest point, one knee up.
3. After GK catches ball, GK in one continuous motion goes down to a crouching position, then jumps up and throws ball back over cross bar to coach.

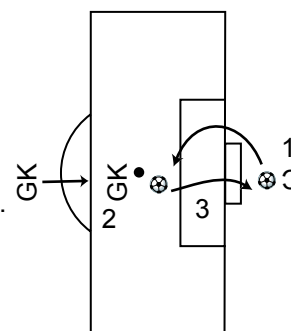

Tactical: Goal Kicks

Goal kicks can be taken from any spot on the 6yd line, regardless on which side of goal the ball went out.

This is a tactical opportunity to change the side of play for the kicking team.

Goal kicks can be taken short to an open defender to build an attack or very deep into the other half.

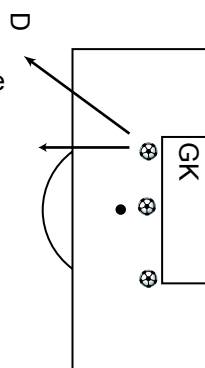

Scrimmage: 3v3 with 2 Balls

Play 3v3 in the penalty box using 2 balls.

X and O can both score on goal.

GK needs to decide which shot to play based on the most dangerous position.

Teams are encouraged to shoot at any opportunity.

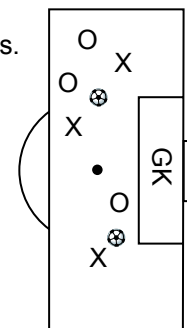



SOCCKER GOALKEEPING PRACTICE # 6

Practice Focus: Ball Handling, Leg Strength, Dives, Crosses

Time: 1.5 hrs

Warm-Up: Ball Handling, Reaction

- Goalkeeper stands with legs apart.
 - holds ball straight up over head.
 - bends down placing ball in front of right foot.
 - brings ball back up overhead and bends placing it in front of left foot.
 Repeats alternating feet, 3 sets of 10 each.
- Upper Body Stretch
- Coach throws balls from top of 6 yd box softly about 2m to side of goalkeeper. Goalkeeper takes two quick steps and catches ball. Alternate sides and vary height of throw from stomach level to overhead.

- Hamstring Stretch
- Shoulder Stretch.
- Shooting.

A and B pass ball back and forth to each other until either decides to take a shot. GK is 3 m off goal line, follows ball and plays angles. GK saves shot.

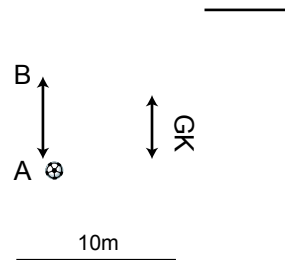

Technique: Turn & Dive, Bouncing Balls

1. Jump-Turn Dive

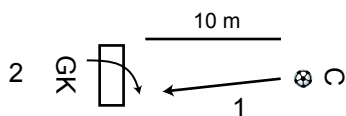

- GK sits with back to hurdle
- Coach throws ball towards hurdle and gives a command "go".
 - On "go" GK jumps up, turns to face coach, dives over hurdles to make save.

2. Save Bouncing Ball

GK stands sideways to hurdle, facing coach.

- Coach throws bouncing ball to side of hurdle.
- GK dives across hurdle and makes save. GK now stands on other side of hurdle and saves next ball.

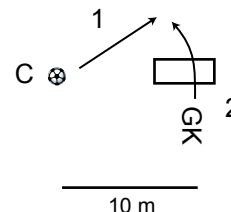

Fitness: Sideways Hop & Dive

- GK stands sideways to a series of evenly spaced hurdles, facing towards coach.
 - GK hops sideways, both feet up together, across hurdles.
 - GK dives over last hurdle to save the ball thrown by coach.
- Reverse direction, 5-10 times each way, giving GK time to stretch/shake legs out in between.

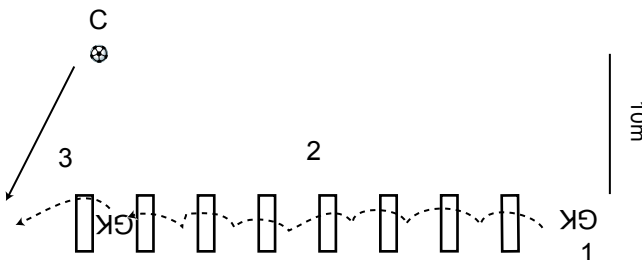

Tactical: Crosses

GK needs to change position relative to where the ball is crossed from.

If ball is near goal line (X1) GK1 plays it like a corner kick and positions closer to near post as ball approaches the goal.

As the ball moves away from line and closer to goal, GK comes towards ball to cut the angle (X2/GK2)

GK must play shot first, be ready for cross.

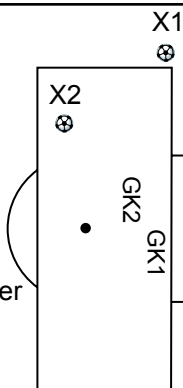

Scrimmage: Crossing & 4v2 in Box

X1 dribbles ball towards goal line and crosses it into box.

X1 then joins three other X and plays 4v2 on goal.

GK decides to catch crossed ball or stay in goal. When play is done, X5 crosses and X4 takes spot of X5.

X's vary from where they cross ball

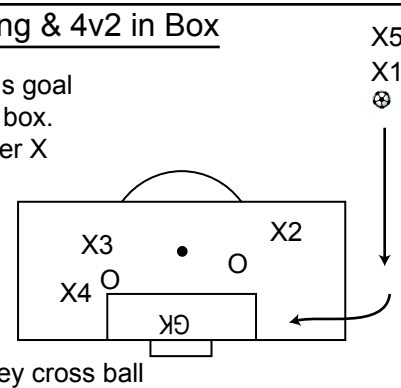



SOCCER GOALKEEPING PRACTICE # 7

Practice Focus: Reflex Dives, Leg Strength, Catching

Time: 1.5 hrs

Warm-Up: Leg Strength, Catching

1. Goalkeeper jogs from goal line to top of penalty box and back, raising knees towards chest while jogging. 3 sets.
2. Upper Body Stretch
3. GK is in crouching position 2m off the goal line. Coach throws ball over GK head and GK jumps up to catch the ball.
4. Hamstring Stretch

5. GK is inside 2m by 2m square. Coach throws ball to GK who catches it while jumping in/out of square:
 1. sideways/feet together
 2. forward
 3. sideways to opposite side
 4. backwards
6. Shoulder Stretch.
7. Coach throws long ball over GK's head. GK takes a couple of small steps backwards, while turning, to catch ball or to dive and push it past the far post.

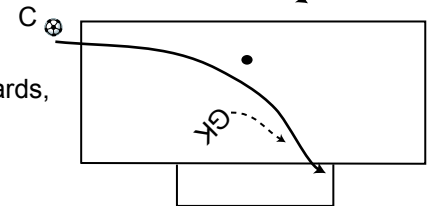
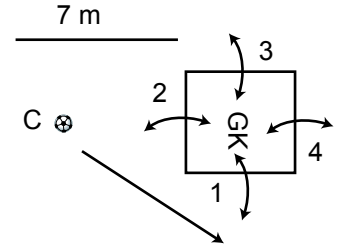

Technique: Reflex Dives

- GK is on goal line facing the back of the goal. GK holds a ball bending low and has legs apart. GK now
1. rolls ball through legs to coach
 2. pivots to face coach and saves shot.

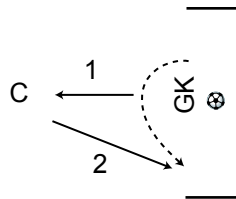

1. GK starts in the center of the goal and runs to either goal post, touching post near ground.
2. GK quickly gets up, pivots and dives to catch a ball
3. thrown towards center of the goal by coach.

alternate sides/posts

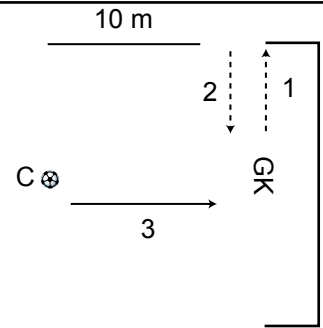

Fitness: Sprint - Jump - Dive

1. GK sprints through cones (slalom)
2. After the last cone, GK gets in ready position and
3. dives to save ball thrown by coach.

GK sprints back and repeats - 10 sets.

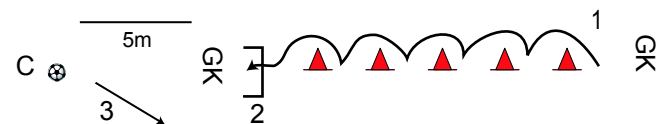
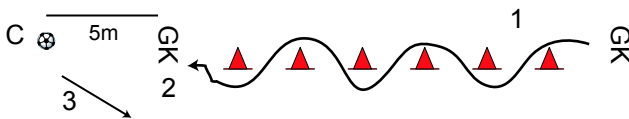

1. GK jumps over a set of cones/hurdles, feet together.
2. After the last cone, GK crawls under a hurdle, gets up into ready position and
3. dives to save a shot from the coach.

GK sprints back and repeats - 10 sets.

Tactical: Wide Distribution Throws

Attackers play 6v6 in one half.

1. A starts play with a long ball into the penalty box.
2. GK comes out and catches ball, being pressured by attackers. GK throws a long ball towards one of the small wide goals at the center line. At the same time a defender sprints to receive the ball thrown by GK.

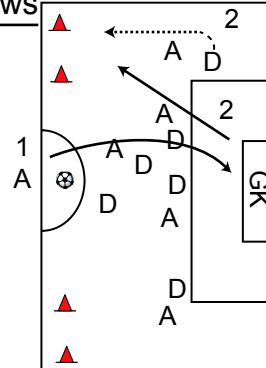

Scrimmage: 4 x 1v1 in Penalty Box

X1/O1, X2/O2, X3/O3, X4/O4 play four 1v1 games in the penalty box.

Players try to take as many shots as possible.

GK sets to play the most dangerous shot and constantly adjusts with the play.

Mix up pairs every 2 minutes.

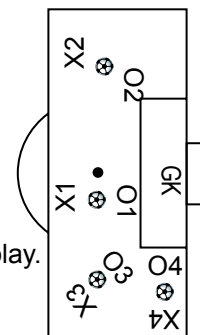



SOCCKER GOALKEEPING PRACTICE # 8

Practice Focus: Agility, Change of Direction Dives, Penalty Kicks

Time: 1.5 hrs

Warm-Up: Agility, Catching, Recovery

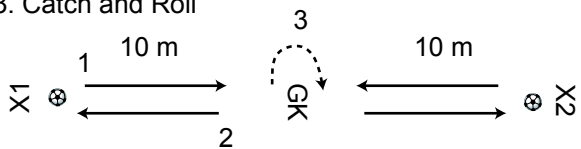
- Goalkeeper sits on ground, legs apart, holding ball with both hands extended out in front. GK tosses ball straight up, lifts legs, moves hands under and through legs, and catches ball before it hits the ground between the legs.
- Upper Body Stretch
- Catch and Roll
 
 - X1 throws ball to GK. GK catches ball and rolls it on ground to X2.
 - GK pivots and repeats with X2.
- Hamstring Stretch
- GK stands with legs apart, ball in hands, and bends down to hold ball on the ground between the legs. Knees are slightly bent. GK rolls balls through the legs behind GK and quickly pivots and makes a diving save of the ball.
- Shoulder Stretch.
- Coach has three balls and stands at the penalty spot. GK is three steps off the goal line. Coach throws a high ball to the side of the GK forcing a diving save. As soon as GK gets up, recovers and is set, coach throws second ball for a diving save. Repeat with third ball. Take a small rest to shake out and repeat 4 more times.

Technique: Change Direction & Dive

1. Turn and Dive

- GK stands holding a ball with one hand.
- GK tosses ball over head behind GK.
- GK pivots and dives to catch the ball.
- Aim for ball to land 2-3 m behind GK.

2. Reverse Step & Dive

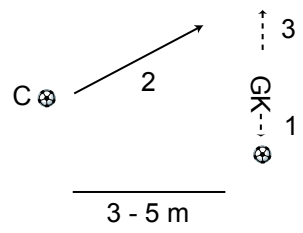
- GK stands one step away from ball. GK steps towards ball, bends down and touches the ball.
 - As GK gets back up, coach throws a ball to the opposite side.
 - GK dives to catch ball.
- Alternate sides - 10 sets each side.
- 

Fitness: Balance - Sprint - Dive

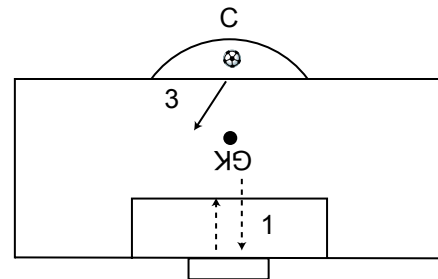

- GK starts at penalty spot with back to goal. GK runs backwards to goal line and bends down to touch the goal line.
- GK sprints to top of 6yd box and gets set.
- GK saves shot from top of penalty box.



Tactical: Penalty Kicks

- There are two main theories about saving penalty kicks:
- Guess the corner of the shot and dive there as the shooter is about to strike the ball.
 - React to the kick by:
 - keeping eye on the ball.
 - as shooter approaches ball, the shooter's planting foot comes into the GK's vision.
 - GK looks at direction of planting foot just before kicking foot strikes the ball. Ball will likely go into direction in which the planting foot is pointing.
 - GK sees ball move and immediately reacts to shot.

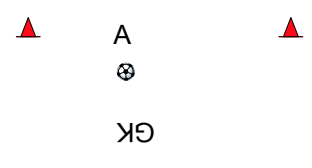
Scrimmage: GK in 1v1

- A plays 1v1 against GK in a 10m x 10m grid. 
- A scores a point by dribbling the ball over any side line. 
- GK scores point by taking ball away from A by diving on ball and getting control with the hands. 



SOCCKER GOALKEEPING PRACTICE # 9

Practice Focus: Continuous Diving, Reaction, Organizing Play

Time: 1.5 hrs

Warm-Up: Catching, Jumping, Diving

- Goalkeeper stands on goal line. Coach is at the top of the penalty box and throws high, arcing balls towards goal which come down around the 6 yd line. GK comes off line and leaps, arms extended up, to catch the ball at the highest possible point. Coach varies position from which to throw the ball.
- Upper Body Stretch
- GK jumps back and forth over ball keeping feet together and raising knees towards chest. Five sets of 20 jumps (1 jump = back and forth).
- Hamstring Stretch
- GK kneels in front of the coach. Coach has a ball in each hand, arms extended sideways from the coach. Coach drops one of the balls and GK dives diagonally forward to catch the ball before it hits the ground. Coach mixes up which ball is dropped to force GK to react.
- Shoulder Stretch.
- Coach sets up a shooting drill to work on areas identified as GK's weakness. For example, focus can be on low shots to the weak side of the GK.



Technique: Continuous Saves

1. Shots from Both Sides of Goal

GK starts at one post of a regular width goal.

- A throws high ball to GK who catches it and throws it back to A.
- GK pivots to face B.
- B takes a low shot to opposite post and GK makes a diving save.

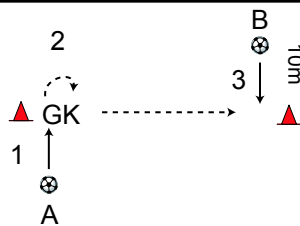

- A shoots and GK saves.
 - GK recovers, sets in next goal facing B and saves shot.
 - Repeat facing C.
- Reverse order of shots for 6 full sets.

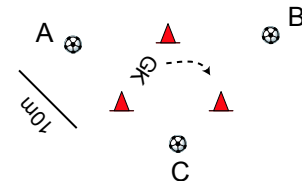

2. Shots on three Goals

3 full size goals set up as a triangle.

Fitness: Triple Dive - Recovery - Dive

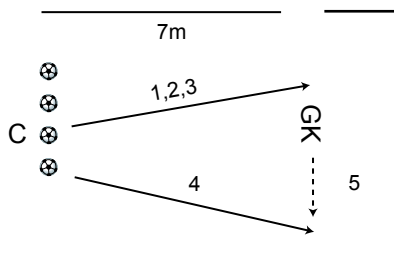

GK is kneeling in the center of the goal, facing the coach.

Coach rolls ball (1) to the right of the GK. GK dives to side, gets ball, throws ball back to coach, and returns to kneeling position. Repeat rolling two more balls (2,3) to the same side.

After the third ball, coach throws the last ball (4) high to the opposite post of the previous rolls. GK now jumps from kneeling position (5) and dives to make a save. Do 3 sets on right and 3 on left side.

Tactical: Organizing Play

The goalkeeper is ideally suited to organize the entire team because GK has the vision of the entire field.

Play a half field game using 6 attackers against the GK and 4 defensive players. Attackers always start with the ball.

GK must tell defenders whom to challenge and whom to mark. Coach stops play at random and awards the attacking team a free kick. GK sets up wall and positions defenders.

Scrimmage: 4v6

On a field twice the size of the penalty box, A play 6v4 vs. D. As try to score. After D gains possession they must pass the ball to a player D making a run outside the field. Play then restarts with As.

GK must organize defenders and provide clear instructions on challenging & covering.

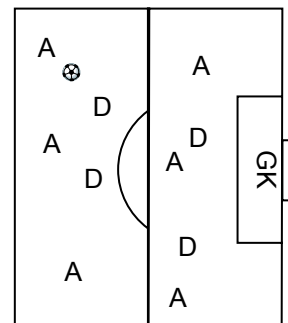



SOCCER GOALKEEPING PRACTICE # 10

Practice Focus: Catching, Back Dives, Angles, Long Balls

Time: 1.5 hrs

Warm-Up: Catching, Running, Passing

1. Goalkeeper starts at the top of the 6yd box facing the coach who is at the penalty spot. GK runs backwards to goal line and catches ball thrown by coach high and above GK.

2. Upper Body Stretch

3. GK runs from goal post to goal post touching the bottom of each post. 10 times back and forth.

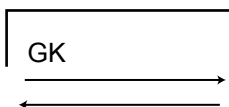

4. Hamstring Stretch

5. Ball Control

1. Coach passes ball to side of goal.
2. GK sprints to control ball and
3. passes it back to coach.

6. Shoulder Stretch.

7. Play a 4v4 game in the penalty box. When defenders have the ball, they must pass it back to GK who kicks it out of the box. Play restarts with attackers.

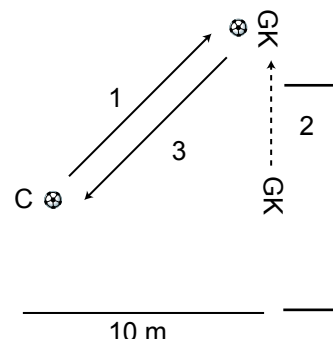

Technique: Diagonal Backward Dives

GK is in normal position playing proper angle anticipating a shot from coach (C). Coach throws ball hard in an arc over top of the GK towards far post.

GK takes a couple of quick shuttle steps backwards towards the far post and on the last step pushes off with the left foot (for situation shown in diagram) and while leaping backwards rotates to push ball past post. Decide on which hand to use to push ball.

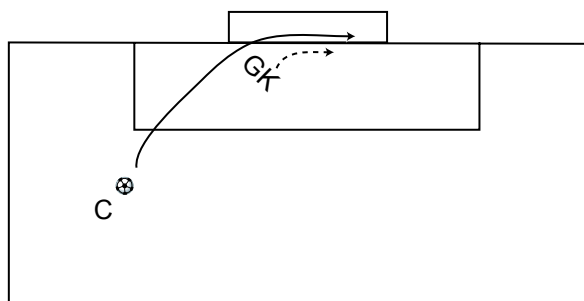

Fitness: Rapid Fire

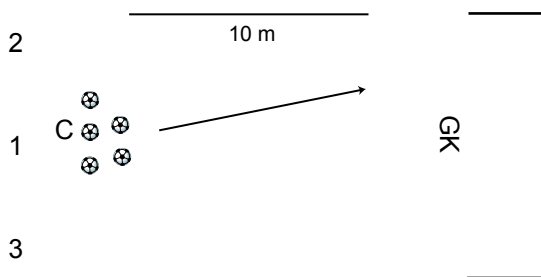

Coach has five balls and throws them at the goal from position (1).

GK Takes proper position (angle, distance) and saves each throw. As soon as GK has recovered from a save, the next ball is thrown.

Repeat with five balls from positions (2) and (3).

GK needs to recover very quickly after a save.

Tactical: Long Balls

A plays a long ball to goal. A1/D1 and A2/D2 chase ball in. GK starts near top of penalty box, sprints out and clears ball into other half. If GK cannot get to ball before A/D pair, then GK retreats to 6yd box and defends the A v D game.

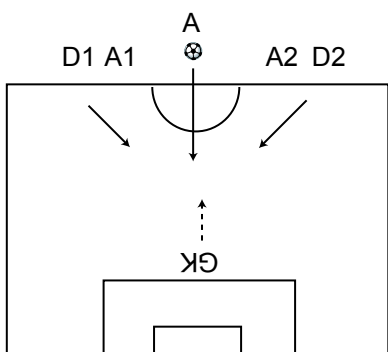

Scrimmage: 2v5 in Penalty Box

5 attackers v 2 defenders play freely inside the penalty box.

Attackers must set up and get as many shots as possible.

They need to move quickly forcing GK to move with play and adjust position.

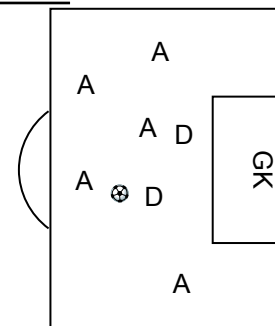

Goalkeeping

Warm-Ups



Warm Up # 1: Catching, Diving

1. Shuttle Run/Stretch #1

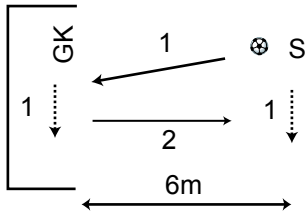

1. While GK & S sidestep across goal, S throws ball to GK. (above head, chest high, ground)
2. GK catches/picks up ball and throws it straight back to S.
3. Shuttle back and forth across goal 6 times.

2. Sit and Catch/Stretch # 2

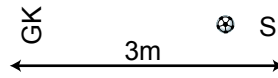

GK sits with legs apart. S throws ball at GK, changing pace of throws. GK catches, recovers to sitting position and throws ball back. Extend GK to fall backwards and sideways.

3. Kneel and Catch/Stretch #3

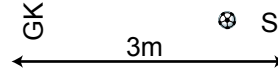

GK on knees. S throws ball as in exercise 2 above. GK catches, recovers, throws ball back

Stretch # 1: Upper Body

GK stands, legs shoulder width apart.

- GK holds ball with both hands, arms straight and extended back over head, - 20 secs.
- GK holds ball straight out front - 20 sec.
- GK, knees slightly bent, holds ball and pushes arms back between legs
- 3 sets

Stretch # 2: Hamstrings

GK sits with legs apart, holding ball with both hands. GK extends arms to hold ball over right foot - holds 20 sec. Alternates holding ball over each foot three times.

Stretch # 3: Shoulders

GK stands 2 steps beside goal post extending arm near post above head leaning against post. Hold each arm 20 secs, 3 repeats.

Coaching Points/Progression

1. The server in the shuttle run dictates speed. Start slow and then increase the pace. Mix up throws. For the last few throws, lead the keeper with the throw extending her/him. Ask goalie to give a precise throw back to the server forcing increased concentration and focus.
2. Start with throws close to the body and allow time for GK to recover. Focus on perfect catching (hand position) and diving techniques. Then pick up pace and extend the reach of the keeper by throwing further away from their body. You can progress the drill by working with two balls. Ask keeper to throw ball to server on the way back up and ask server to throw the second ball as soon as keeper is upright. This requires coordination skills on part of the server.

Stretches: In stretch # 2 challenge keepers to hold ball in front of foot - ball on the ground.

Note: check www.soccerpracticebooks.com/gkbasics.html for pictures of stretches & techniques. add your own or keeper's own stretches as desired and needed.

Coach's Notes



Warm Up # 2: Flexibility, Coordination

1. GK sits with legs apart, holding ball in front. GK tosses ball straight up, lifts both legs, moves hands under legs and catches ball. Repeat and challenge GK by reducing height of toss.
2. Upper Body Stretch
3. GK walks while holding ball straight out. Alternately move right foot and left foot up to ball, touching ball with laces. Walk from goal line to top of penalty box and back three times.
4. Hamstring Stretch
5. Repeat exercise # 3 while jogging slowly.
6. Shoulder Stretch
7. Coach rolls, throws (low - knee high; mid - stomach high; high - chest/head; above head) ball to goalkeeper from various angles and distances starting at the penalty spot. GK catches ball and throws it back to coach. Allow GK time to recover and reset in proper "ready" position.

Coaching Points/Progression

1. You may start by asking Gk to start without a ball to get used to the motion of legs and hands. Progress by having a coach hold the ball and dropping it for GK to catch after moving hands under legs. Finally ask GK to throw ball. Start slow and build confidence. On the other hand ask advanced GK to go through the moves faster and faster throwing the ball lower and lower.
3. Once the motion is fluid by the keeper, ask them to walk faster.
5. keep the focus on accuracy, i.e. keeping arms horizontal and extended and touching ball with the laces.
7. GK throws ball back as soon as it is caught and then quickly returns to the starting position to receive the next ball. Increase speed and difficulty of throw, even requiring a diving save.

Coach's Notes



Warm Up # 3: Coordination, Catching

1. GK runs from goal line to the top of the penalty box and back. While running, GK tosses ball with right hand over the head (sideways) and catches it with the left hand. GK then throws with left hand and catches with the right. Repeat twice from goal line to top of box and back.
2. Upper Body Stretch
3. GK stands with legs apart, knees slightly bent, and holds ball behind the head. GK drops ball and quickly moves hands through legs to catch the falling ball (behind the back).
4. Hamstring Stretch
5. GK lies on stomach holding ball in hands with arms extended straight ahead. GK throws ball straight into the air, rotates quickly to lie on their back, and catches ball.
6. Shoulder Stretch
7. GK is two steps off the goal line. Coach throws a ball from the penalty spot on goal, over GK head. GK jumps and tips ball with the fingers over the cross bar of the goal.

Coaching Points/Progression

1. GK may initially follow the ball with their eyes to catch it. Eventually, they should "feel" where the ball is and throw/catch it while looking straight ahead. They also need to throw the ball slightly forward at the same speed of their own movement so they don't need to reach back.
3. You may want to have GK work with a partner who holds the ball and drops it while GK holds hands through the legs. This allows GK to get used to catching in this awkward position. Then progress to GK holding/dropping/catching the ball. be patient - this is not easy.
5. The key point here is for the GK to catch the ball while lying flat on their back with arms fully extended. Advanced goalies can try to do a complete roll and catch the ball while lying back on their stomach.
7. Start with easy, lobbing throws - it is o.k. if GK initially catches the ball. Then increase the pace of the throw - lob just under the cross bar. this may force GK to leap backwards - push the ball over the bar, and collapse dive to the ground.

Coach's Notes



Warm Up # 4: Jumping, Abdominals

1. Jumping

- GK faces hurdle or obstacle.
- GK jumps over hurdle and makes 1/2 turn in the air.
- GK lands on other side facing hurdle.



2. Upper Body Stretch

3. Abdominal Strength 1

- GK lies on back holding ball with both hands, arms extended all the way behind the head.
- GK rotates one complete turn holding on to the ball. When lying on back again, GK brings ball to the laces of both shoes while pulling both knees towards the chest.

4. Hamstring Stretch.

5. Abdominal Strength 2

- Two goalkeepers work as partners.
- GK 1 stands and holds a ball next to their right hip.
- GK 2 lies on the side away from GK 1 with both feet locked between GK 1's feet to prevent sliding.
- GK 2 now lifts upper body and touches the ball held by GK 1 with both hands.
- Do 4 sets of 10 for each GK, alternating side GK lies on.

6. Shoulder Stretch

7. Rapid Shooting

4-6 players line up at the top of the penalty box and take shots, giving GK enough time between shots to 'reset'.

Coaching Points/Progression

1. Make sure goalie keeps feet together and raises knees during the jump. If you don't have hurdles, use equipment bags. Increase the height of the hurdle with ability and size of keeper. Once the technique is executed perfectly, ask for increased speed.
3. Start slow and increase the pace, all the while focusing on execution.
5. You may start without a ball to see how high the keeper can raise off the ground. Then add the ball at the appropriate height and challenge holding the ball a little higher with each set.
7. Ask the shooters to start giving the keeper a chance to make some saves. then challenge with harder shots closer to the posts. Goalie needs to focus on the save first and then on the quickest possible recovery to the "ready" position. GK also must play the proper angle to the next shooter and challenge the shooters by coming off the line.

Coach's Notes



Warm Up # 5: Jumping, Flexibility

1. Jumping

- throw ball high over GK head.
- GK jumps up, timing the catch of the ball at it's highest point.
- while reaching for the ball, GK pulls one knee up towards chest.

2. Upper Body Stretch

3. Catching

- throw a ball from 5m away toward GK chest.
- GK jumps just high enough for ball to meet GK's body at the pectoral muscles.
- GK bends arms and cradles ball into chest.

4. Hamstring Stretch.

5. Flexibility

- Two goalkeepers work as partners.
- They lie on stomach facing each other with a hurdle or other obstacle in between them.
- GKs throw ball to each other across the hurdle.
- GKs catch ball with two hands, raising upper body off the ground as much as they comfortable can.

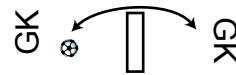

6. Shoulder Stretch

7. Catching under Pressure

coach throws high ball from the top of the penalty box. One forward goes for a header. GK challenges to catch ball.

Coaching Points/Progression

1. This is a key competency for a top class goalkeeper. They need to judge the flight of the ball and their ability to jump to catch the ball at the GK highest, completely vertical extended, point. At the same time one knee needs to be brought up as protection against challenging attackers. Once the technique and timing are right, throw the ball high in front of keeper asking them to move forward first before jumping. Then throw to sides, mixing up throws.
3. once catching technique is established, challenge the keeper with higher throws, all the while requiring keeper to jump and catch ball against chest.
5. This requires some base flexibility. If keeper struggles to raise body off ground - do not force them This means they have to slowly build the flexibility first. You can ask them to lie on their backs and catch the ball moving upper body up - this trains the abdominals.
7. This is a good time to remind keeper of raising one knee trained in exercise #1. Make sure that you favour the keeper with the throw to avoid any collision with the forward.

Coach's Notes



Warm Up # 6: Ball Handling, Reaction

1. Goalkeeper stands with legs apart.
 - holds ball straight up over head.
 - bends down placing ball in front of right foot.
 - brings ball back up overhead and bends placing it in front of left foot.Repeats alternating feet, 3 sets of 10 each.

2. Upper Body Stretch

3. Coach throws balls from top of 6 yd box softly about 2m to side of goalkeeper. Goalkeeper takes two quick steps and catches ball. Alternate sides and vary height of throw from stomach level to overhead.

4. Hamstring Stretch

5. From penalty spot, coach rolls balls straight at goalkeeper. Goalkeeper comes forward and drops to one or both knees to safely pick up ball and pulls it to chest.

6. Shoulder Stretch.

7. Shooting.

A and B pass ball back and forth to each other until either decides to take a shot. GK is 3 m off goal line, follows ball and plays angles. GK saves shot.

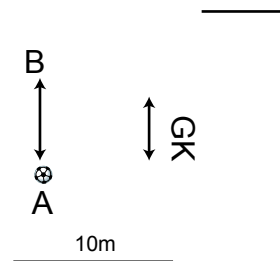

Coaching Points/Progression

1. Knees must be slightly bent. Start slow and increase pace with each set.
3. It is critical that GK takes quick shuttle steps to follow the essential principle of getting the body behind the ball. The tendency may be for GK to reach for the ball - do not allow this. They must shuttle quickly to catch the ball with their body squarely behind it. Increase pace of throws.
5. There are many techniques for keepers to stop and cover balls coming at them on the ground. Most professionals know drop with two knees on the ground cradle the ball in both arms, and drop forward smothering the ball (protection) with their upper body. All the while they keep their head straight to see any on-rushing players. It is important to decide on the technique that works best for your goalie. They must get down and get their body behind the ball. Under no circumstance are they allowed to pick the ball up while standing.
7. Goalie needs to simply take a small step and pivot to face the player with the ball straight on. GK must be in crouching position to be ready for a quick dive.

Coach's Notes



Warm Up # 7: Leg Strength, Catching

1. Goalkeeper jogs from goal line to top of penalty box and back, raising knees towards chest while jogging. 3 sets.

2. Upper Body Stretch

3. GK is in crouching position 2m off the goal line. Coach throws ball over GK head and GK jumps up to catch the ball.

4. Hamstring Stretch

5. GK is inside 2m by 2m square.

Coach throws ball to GK who catches it while jumping in/out of square:

1. sideways/feet together
2. forward
3. sideways to opposite side
4. backwards

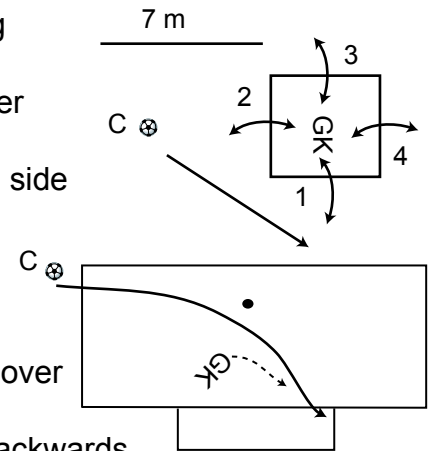

6. Shoulder Stretch.

7. Coach throws long ball over GK's head. GK takes a couple of small steps backwards, while turning, to catch ball or to dive and push it past the far post.

Coaching Points/Progression

1. Easy jogs. If GK is comfortable with the motion, add variations such as touching ground, easy vertical leaps, holding ball while jogging, etc. Make it a little more fun !!
3. The crouch should be such that the buttocks of the keeper are level with the knees. This is a quadricep strengthening exercise to increase vertical leaping height.
5. Ideally you have hurdles to mark the square forcing the proper jumping technique by the keeper. Keeper catches ball while standing - no diving required.
7. The keeper needs to turn while shuttling backwards keeping eyes on the ball at all times. The timing and pace of the throw are important and this drill requires a good understanding between server and keeper. Challenge the keeper to a full extension dive by throwing the ball at the intersection of cross bar and far post. Vary distance from which to throw and pace of throw to challenge the keeper. The point of this drill is that the keeper has to be positioned to stop a shot, but be ready to dive backwards if the striker lobs it over top.

Coach's Notes



Warm Up # 8: Agility, Catching, Recovery

1. Goalkeeper sits on ground, legs apart, holding ball with both hands extended out in front. GK tosses ball straight up, lifts legs, moves hands under and through legs, and catches ball before it hits the ground between the legs.

2. Upper Body Stretch

3. Catch and Roll

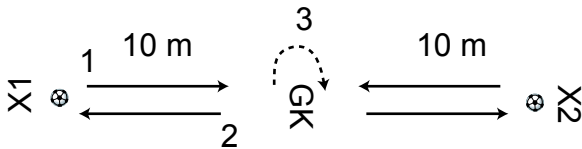

1. X1 throws ball to GK. GK catches ball and
2. rolls it on ground to X1.
3. GK pivots and repeats with X2.

4. Hamstring Stretch

5. GK stands with legs apart, ball in hands, and bends down to hold ball on the ground between the legs. Knees are slightly bent. GK rolls balls through the legs behind GK and quickly pivots and makes a diving save of the ball.

6. Shoulder Stretch.

7. Coach has three balls and stands at the penalty spot. GK is three steps off the goal line. Coach throws a high ball to the side of the GK forcing a diving save. As soon as GK gets up, recovers and is set, coach throws second ball for a diving save. Repeat with third ball. Take a small rest to shake out and repeat 4 more times.

Coaching Points/Progression

1. Once comfortable and successful with technique, decrease height and increase pace of.
3. X1 and X2 need to throw straight at GK initially. They can vary height of throw forcing keeper to drop on knees or leap vertically (one knee up), Progress to throwing ball one step to side of keeper forcing a quick shuttle step. Increase pace by throwing as Gk is turning forcing a fast pivot and very quick "set" before the catch. BUT - keep goalie successful.
5. Ask GK to vary the pace of the roll of the ball to force a quick turn and collapsing save or a quick turn and full extension save. You want reasonably soft ground for this drill. GK may want to play it safe with soft rolls of the ball. Challenge them to challenge themselves.
7. Start by throwing all three balls to the same side, then the other side, and finally mix up sides. Play to the keeper's ability initially, by throwing ball mid height and closer to the keeper. Then progress by throwing closer to the post, higher or on the ground, and at faster pace. Always encourage keeper and end with "catchable balls" - SUCCESS IS KEY TO CONFIDENCE.

Coach's Notes



Warm Up # 9: Jumping, Diving

1. Goalkeeper stands on goal line. Coach is at the top of the penalty box and throws high, arcing balls towards goal which come down around the 6 yd line. GK comes off line and leaps, arms extended up, to catch the ball at the highest possible point. Coach varies position from which to throw the ball.
2. Upper Body Stretch
3. GK jumps back and forth over ball keeping feet together and raising knees towards chest. Five sets of 20 jumps (1 jump = back and forth).
4. Hamstring Stretch
5. GK kneels in front of the coach. Coach has a ball in each hand, arms extended sideways from the coach. Coach drops one of the balls and GK dives diagonally forward to catch the ball before it hits the ground. Coach mixes up which ball is dropped to force GK to react.
6. Shoulder Stretch.
7. Coach sets up a shooting drill to work on areas identified as GK's weakness. For example, focus can be on low shots to the weak side of the GK.



Coaching Points/Progression

1. Make sure balls are thrown stright at keeper and high enough to force keeper to jump. progress by throwing the ball to either side of the keeper.
3. Use hurdles if available and increase height of the hurdle to challenge keeper.
5. Vary the distance of the keeper to the ball to force an extension dive requiring keeper to quickly push themselves forward and downward towards the ball. Then reduce the distance to force a "collapsing" dive which lets gravity dictate the pace at which keeper can get down to the ground to stop the ball.
7. Ask the keeper wht they think their weakness is and see if you agree !! Talk about it.

Coach's Notes



Warm Up # 10: Catching, Running, Passing

1. Goalkeeper starts at the top of the 6yd box facing the coach who is at the penalty spot.
GK runs backwards to goal line and catches ball thrown by coach high and above GK.
2. Upper Body Stretch
3. GK runs from goal post to goal post touching the bottom of each post. 10 times back and forth.



4. Hamstring Stretch
5. Ball Control
 1. Coach passes ball to side of goal.
 2. GK sprints to control ball and
 3. passes it back to coach.
6. Shoulder Stretch.
7. Play a 4v4 game in the penalty box. When defenders have the ball, they must pass it back to GK who kicks it out of the box.

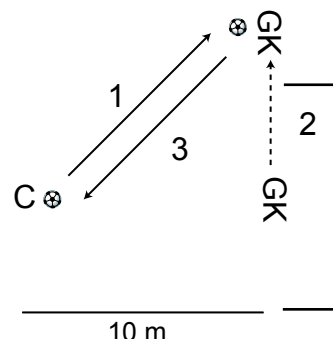

Play restarts with attackers.

Coaching Points/Progression

1. Start so that keeper catches ball 2-3 steps in front of the goal line. Progress to force keeper to run backwards faster and jump higher. Tall and experienced keepers can be forced to tip ball over cross bar.
3. Push keeper to sprint between posts and don't let them cheat. they must touch ground at the bottom of the post.
5. Start with slow and easy passes. Ask for two touches from keeper - one to control the ball, the second to pass. Increase pace of pass to keeper and REDUCE quality of pass, simulating mistakes by a defender passing the ball back. Bouncing balls, balls towards the goal, etc.
7. Make sure defenders have a clear line of passing to the keeper. This should force defenders to make good decisions and also challenge the keeper with some poorly played passes. Keeper needs to transition from being ready for a shot when attackers have the ball to be in the right position for a pass back when defenders get the ball. Never leave the goal too early.

Coach's Notes

Goalkeeping

Technique



Technique # 1: Diving, Distribution

Crouch & Dive

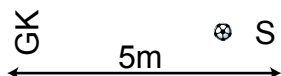

GK is in crouching position.

S throws high balls left and right.

GK dives and catches.

Increase difficulty as appropriate

Dive & Distribute

1. S throws low ball to GK right.
 2. GK dives, saves, recovers and throws ball to A.
 3. S throws high ball to GK left.
 4. GK dives, saves, recovers and throws ball to B.
- Repeat

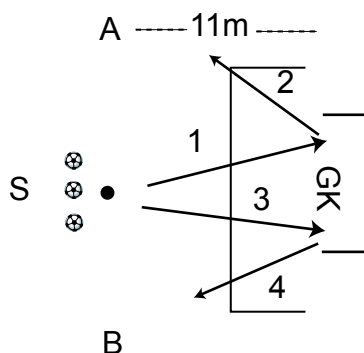

Coaching Points/Progression

Crouching Positions:

In order to get maximum distance and speed for a dive momentum must be generated to use the power of the legs to the maximum. This momentum is generated by going from an upright or slightly bent (knees bent) position into a crouching position and then pushing off one leg to dive. However, when shots are coming from a close distance, the time required to get down to generate momentum is not available - the ball will be in the net before the dive starts. Therefore, the closer the shooter is to the keeper, the lower in the crouching position the keeper needs to be to directly explode into the dive. At the distance of 5m in this drill, buttocks should be level to the knees.

Dive & Distribute:

Progress the drill by increasing the distance of A and B from goal. Ask the keeper to dive to the side of A but distribute across to B and vice versa. For younger and smaller keepers reduce the throwing distances.

Coach's Notes



Technique # 2: Reaction Dives

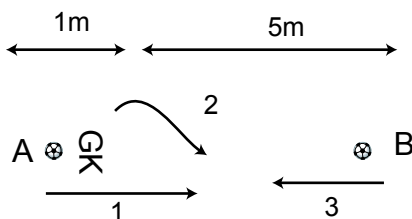

GK faces A with legs apart in the crouching 'ready" position.

1. A rolls ball through GK legs.
2. GK turns and dives to save ball, then recovers and gets up into ready position as quickly as possible.
3. While GK is recovering, B throws a high ball to the opposite side for a diving save by GK.

A and B time their throws to keep GK in motion while allowing recovery time.

Coaching Points/Progression

1. It would be great if you have three keepers to work together on this drill.
2. The crouching positions must be very low to explode into dive.
3. Vary the distance of the first dive from a short collapsing dive to a fully extended dive.
4. vary the second throw from throwing it to goalie's feet, chest, over top of head, to either side requiring little to full extension dives.
5. Insist on proper technique and stress the fundamentals of getting behind the ball and getting both hands on the ball.

It is important for the person working with the keeper(s) to build a rapport with them and to understand their strengths, weaknesses, and preferences. Use this knowledge to provide the keeper with lots of successes, but also with some "surprises" or challenges to improve performance and build skill and confidence. Relate exercises to game situations as much as possible, preferably to actual experiences of the keeper.

Coach's Notes



Technique # 3: Jumping, Diving

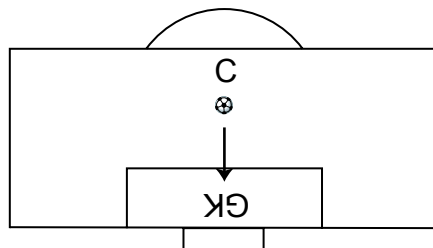

Jumping:

1. GK stands one step off the goal line in a crouched position.
2. Coach (C) throws high ball over GK head.
3. GK jumps up and deflects ball over cross bar or catches it.

Diving:

1. GK stands with legs apart and holds ball at the right foot.
2. GK rolls ball back through legs, turns (pivots) and dives back to grab ball with both hands.
3. Alternate right and left.

Coaching Points/Progression

Jumping:

Normally the keeper would be in a medium crouching positions (buttocks height between knees and chest) to be able to react to a high ball within a few steps of the keeper or to be able to quickly crouch lower to generate momentum for a full extension dive to a corner. However, this drill is to build leg strength and vertical jumping ability, so we recommend a complete low crouch. The ball should be thrown with force just underneath the cross bar forcing the keeper to explode out of crouch. You may progress the pace of the throw from allowing a catch to forcing a deflection with the finger tips.

Diving:

Keeper's knees should be bent to allow quick dive. Keeper will train reaction speed as well by having to coordinate the direction of the pivot with the direction of the ball, i.e. roll ball to the left, pivot on left foot. Vary the strength of the roll to force collapsing and extension dives.

Coach's Notes



Technique # 4: Backward Dives

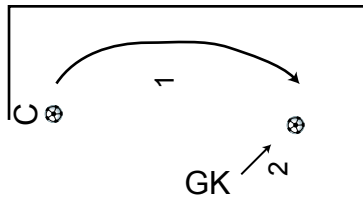

Coach stands inside post with ball.

GK stands with back to goal, 3-4 m in front of goal.

- 1, Coach throws ball in a high arc across goal line, giving verbal signal to GK when ball is thrown.
2. GK looks over shoulder and dives backwards to catch ball.

Coaching Points/Progression

Keepers are typically uncomfortable with this drill because it puts them out of their routine and comfort zone, which is one of the key learning points of the drill. The keeper initially looks over their shoulder at the post the ball will be thrown to, NOT at the coach holding the ball. The verbal signal from the coach tells the keeper to expect the ball and prepares them for a super fast reaction move. As soon as the ball enters the keeper's vision the keeper must anticipate the flight of the ball and react with an explosive dive from the crouching position.

It is important to work with the keeper to adjust the starting location of the keeper, the arc of the throw, and the pace of the throw. The important point is to have the keeper get to the ball. If the keeper gets to the ball 5 out of 10 times - that is success. At that point you can increase the challenge by not giving a verbal signal and let the keeper react strictly to the sight of the ball.

This is one of our most challenging exercises - you may need to stop and revisit at another time.

Coach's Notes



Technique # 5: Diving after Motion

1. Double Jump Dives

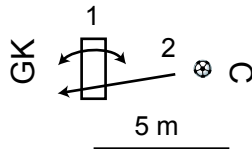

1. GK jumps forwards and backwards across a hurdle.
2. As GK lands after jumping backwards, coach throws a ball for a diving save.

2. Somersault & Dive

1. GK starts on goal line facing coach (C) and makes a somersault (roll) forward.
2. As GK comes up out of the roll, coach shoots from the top of the box. GK quickly sets and makes diving save.

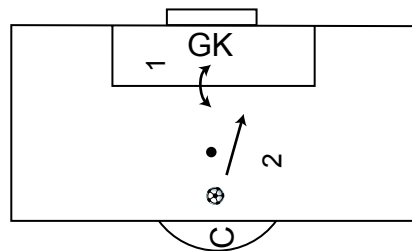

Coaching Points/Progression

Double Jump Dives

1. If you do not have hurdles, use equipment bags or any other obstacle a up to 30 cm (1 ft) in height.
2. Keeper must jump keeping feet together and knees up as much as possible.
3. Keeper needs to land in low crouching position to explode into dive.
4. Coach must time throw to allow keeper to be set before the ball leaves the coach's hand.
5. Progress throws from near the keeper to either side (3m), from low to high balls, even bouncing balls.

Somersault & Dive

Although a straight forward, well executed somersault is preferable, this is not about teaching somersaults. As long as the keeper gets down, makes some sort of roll, and comes straight up. Keeper sets in crouch. See notes 3-5 above - they are the same for this drill.

Coach's Notes



Technique # 6: Turn & Dive, Bouncing Balls

1. Jump-Turn Dive

GK sits with back to hurdle

1. Coach throws ball towards hurdle and gives a command "go".

2. On "go" GK jumps up, turns to face coach, dives over hurdles to make save.

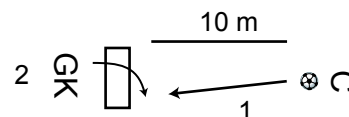

2. Save Bouncing Ball

GK stands sideways to hurdle, facing coach.

1. Coach throws bouncing ball to side of hurdle.

2. GK dives across hurdle and makes save.

GK now stands on other side of hurdle and saves next ball.

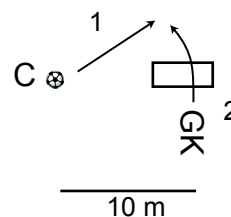

Coaching Points/Progression

Jump - Turn - Dive

Keeper needs to jump up and rotate at the same time to be in a "low crouch ready" position immediately when the feet hit the ground. You may need to allow a two step process initially, jump up into a crouching position, then pivot. Coach needs to adjust the timing of the "go" and the pace of the throw with the movement of the keeper. You may need to start by waiting for keeper to set after the "go" command and delay the throw. This is a slightly forward dive to the side - very difficult. Increase the challenge through earlier and wider throws AFTER success.

Save Bouncing Ball

This is a reaction dive, i.e. keeper needs to see the ball leave, judge the flight of the ball, and then react super fast with a dive. Keeper starts in low crouch. Given it is a bouncing ball, it is o.k. for keeper to parry (push ball wide with hands).

You may wish to start both drills with a very low hurdle or no hurdle at all. The purpose of hurdle is to force a proper dive getting both feet off the ground.

Coach's Notes



Technique # 7: Reflex Dives

GK is on goal line facing the back of the goal. GK holds a ball bending low and has legs apart. GK now

1. rolls ball through legs to coach
2. pivots to face coach and saves shot.

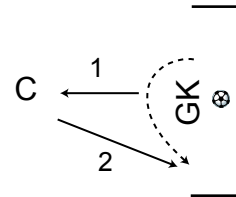

1. GK starts in the center of the goal and runs to either goal post, touching post near ground.
2. GK quickly gets up, pivots and dives to catch a ball
3. thrown towards center of the goal by coach.

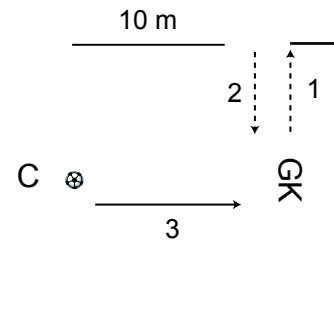

alternate sides/posts

Coaching Points/Progression

1. It is important that the keeper rolls the ball as hard as possible to the coach to reduce the reaction time to the shot. If that proves to be too difficult, then have the coach start with the ball, shoot at either post and give a command ("go") to keeper to get keeper to turn. The turn by the keeper is a fast pivot. Keeper then needs to immediately recognize the direction and pace of the ball and make a reflex dive to save it. Start with low pace shots close to the keeper and progress by increasing pace of shot and distance from keeper. Push the keeper to new levels of saves, but do not serve balls the keeper could never get. Build confidence.
2. Keeper runs to post facing post, not shuttling sideways - although that can be a variation of this drill. Keeper must come from touching post into a low crouch while pivoting to face the coach. This allows an immediate dive. Coach starts with "easy" balls - mid height, center of goal and then progresses to high balls, low balls and further to the far post, but always within reach of the keeper.

Over time, keeper should be able to get to faster paced and higher/lower balls.

Coach's Notes



Technique # 8: Change Direction & Dive

1. Turn and Dive

GK stands holding a ball with one hand.

GK tosses ball over head behind GK.

GK pivots and dives to catch the ball.

Aim for ball to land 2-3 m behind GK.

2. Reverse Step & Dive

1. GK stands one step away from ball. GK steps towards ball, bends down and touches the ball.

2. As GK gets back up, coach throws a ball to the opposite side.

3. GK dives to catch ball.

Alternate sides - 10 sets each side.

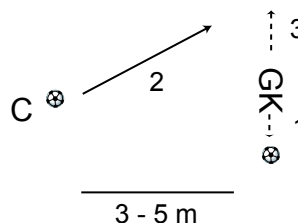

Coaching Points/Progression

Turn & Dive:

GK should stand with knees slightly bent. It is important that the keeper's motions are synchronized such that the throw is executed properly first. Once the ball leaves keeper's hand, keeper pivots **into a low crouch** and dives to get the ball. keepers will have a tendency to throw and pivot at the same time - this usually results in a poor throw. It may take some time to get the movements right. Once the keeper is comfortable, ask them to challenge themselves with harder throws forcing more extended dives. Tip: the higher the throw initially, the more time to pivot and dive.

Reverse Step & Dive:

Coach needs to start with "easy throws" to get the keeper comfortable, but also for the coach to practice proper release timing and pace of throw. Once keeper and coach are coordinated, coach can increase the challenge by releasing the ball sooner and vary the height (ground to cross bar height) and pace of the ball.

Coach's Notes



Technique # 9: Continuous Saves

1. Shots from Both Sides of Goal

GK starts at one post of a regular width goal.

1. A throws high ball to GK who catches it and throws it back to A.
2. GK pivots to face B.
3. B takes a low shot to opposite post and GK makes a diving save.

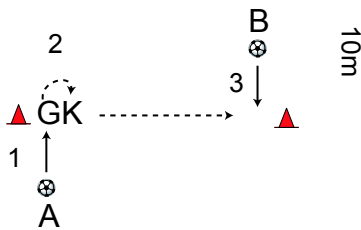

2. Shots on three Goals

3 full size goals set up as a triangle.

1. A shoots and GK saves.
2. GK recovers, sets in next goal facing B and saves shot.
3. Repeat facing C.

Reverse order of shots for 6 full sets.

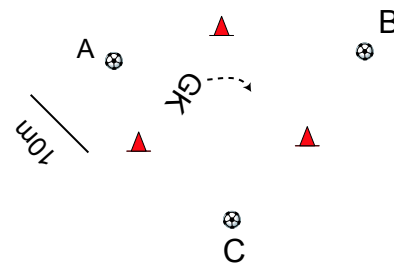

Coaching Points/Progression

Shots from Both Sides of Goal:

Goalkeeper starts with knees slightly bent - semi crouch. The throw should be cross bar height forcing keeper to jump up. Challenge the keeper to catch the ball and throw it back to the server in one motion, ideally before feet plant on ground. Keeper should immediately get into a low crouch to be ready to pivot and use the momentum from coming down into an exploding fully extended dive to save the second shot. Start with the second shot at a pace and distance closer to the keeper to allow the keeper success. Then increase the distance, the pace, and the height of the shot.

Shots on three Goals:

After each shot the keeper needs to quickly recover, hustle into the adjacent goal and set for the next shot. Shooters need to allow keeper to properly set before shooting next. They should vary the shot with respect to the side of the keeper, height, and pace. They need to find a balance between allowing a great keeper little time to set and pushing a novice to set faster.

Coach's Notes



Technique # 10: Diagonal Backward Dives

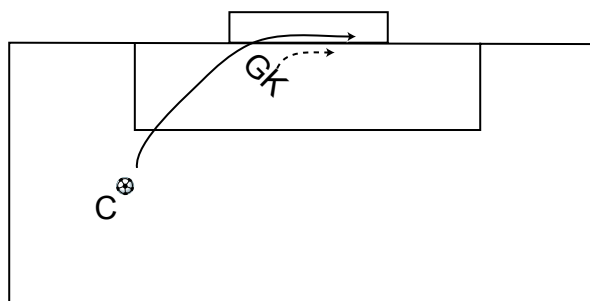

GK is in normal position playing proper angle anticipating a shot from coach (C).

Coach throws ball hard in an arc over top of the GK towards far post.

GK takes a couple of quick shuttle steps backwards towards the far post and on the last step pushes off with the left foot (for situation shown in diagram) and while leaping backwards rotates to push ball past post.

Decide on which hand to use to push ball.

Coaching Points/Progression

This is one of the most difficult tasks for a goalkeeper to master. The key obstacle is FEAR. Keepers can be afraid because they anticipate difficulty in landing in REGULAR positions after the dive, thus fearing discomfort landing on the rib cage. The REGULAR landing allows the keeper to land in the following sequence of touching the ground: thigh - rib, quite often with enough time pull the arm under the body for further cushioning. We therefore recommend to approach this drill with a conversation explaining the above and asking the keeper to be patient. You may want to start by starting with the keeper on their knees and throwing from a closer distance to get them comfortable with the landing technique. The move to throws. The throws have to be near perfect to the top far corner.

Keeper needs to decide with which hand to lead and push the ball after the initial pivot. Some get more distance leading with the same side hand of the foot that they push off with (left foot push - left hand extends for save); others get more distance bringing up the opposite hand (left foot push off - right hand comes up over head and pushes the ball). Speed of movement is key here.

Coach's Notes

Goalkeeping

Fitness Drills



Fitness Drill # 1: Diving, Recovering

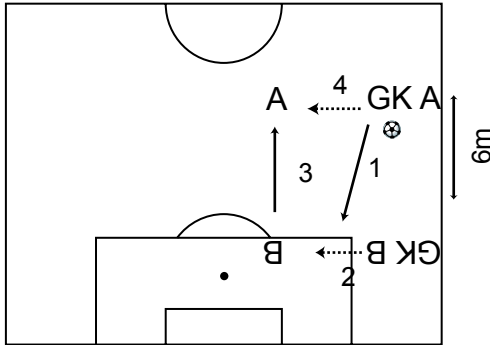

Two GK work together.

1. GK A rolls ball to left of GK B
2. GK B dives, catches ball, gets up and
3. throws to GK A,
4. who has moved straight across GK B.

Repeat across the width of the field.

Coming back GK B rolls and GK A dives.

Repeat twice for each GK making sure they dive to their left and their right side.

Coaching Points/Progression

The key point is for the keepers to work together and to be accurate in their execution. The roll has to be timed, be at the right angle and distance, be at the right pace for the GK making the save to extend fully. Allow the keeper to get set properly before rolling the next ball.

It can easily take one trip across the field and back for the keepers to synchronize.

If the keepers are doing well, progress by throwing high balls for the save and by picking up the pace.

Coach's Notes



Fitness Drill # 2: Circle Dives

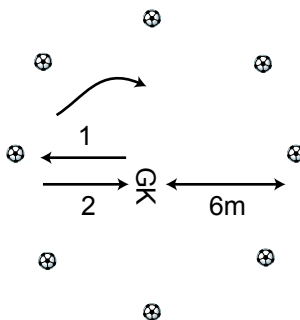

GK is in the center of a circle made with 8 balls. Each ball is 6m away from the center.

1. GK dives to each ball, touching it with the leading hand, i.e. GK dives to the left - touches ball with left hand.
2. GK recovers to center, gets in ready position (low crouch) and dives to each ball. Reverse direction of dive for the second round.

Make sure that the playing surface is soft and GK has protective padding.
Not recommended for hard ground.

Coaching Points/Progression

Some keepers can generate more momentum and diving distance by leading with one hand and then bringing the other hand over the head to the ball. In this particular exercise this will likely cause the keeper to turn and land on their stomach, which is improper goalkeeping technique. Keeper must land on their side. Encourage the keeper to touch the ball with the leading hand.

Allow smaller keepers to take a couple of steps before they dive to ensure success.

This is a difficult drill for goalies but it will show how much courage and endurance your keeper has. Make sure that the ground is soft and/or that the keeper has protective clothes.

If your keepers are comfortable, ask them to recover faster for the next dive.

Keeper always returns to the center of the circle, sets in a crouch and dives again.

Coach's Notes



Fitness Drill # 3: Jump from Laying Position

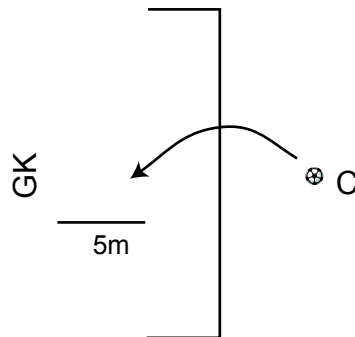

1. GK lies on stomach facing the goal, head at the top of the 6yd box.
2. Coach (C) is behind the goal and throws a high, arcing, ball over top of the cross bar towards the GK.
3. GK jumps up and catches the ball at its highest point.
4. After catching the ball and before getting feet back on the ground, GK throws ball back across the goal to the coach.

Focus on catching the ball before attempting to throw it back in the same motion.

Coaching Points/Progression

You may wish to have some practice runs with a progression to get the mechanics of both the GK and the coach worked out. Have the GK stand initially, jump to catch the ball at the highest point, land on the feet, and throw it back. Then ask the keeper to throw it back before landing on the feet. Then have GK start in laying position, catch ball, and land on feet before throwing it back. Finally, execute the complete drill as intended.

If there is early success, vary the drill by changing the starting position of the keeper; sitting down, laying on back, low crouch.

Coach's Notes



Fitness Drill # 4: Jumping & Diving

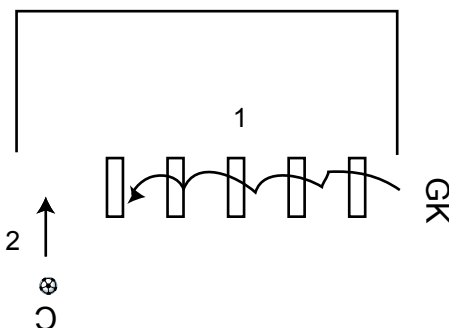

1. GK runs across hurdles and:
 - a. dives over last hurdle, turning on side in air,
 - b. jumps over last hurdle, rotates in air to land facing coach (C), then dives,
 - c. jumps over last hurdle, jumps backward over same hurdle, then dives again over the hurdle, turning on side in air
 - to
 2. catch the ball thrown by coach with two hands.
- Repeat (a)-(c) five times.

Coaching Points/Progression

Place enough hurdles or other obstacle to reach from the goal post the keeper is starting on to about half way across the goal. If you want more extended dives from the keeper, you can place the hurdles next to the post and adjust the point from where the keeper dives this way.

Place the hurdles close enough to force the keeper to small steps with knees up, avoiding long strides. Select the right height of hurdles for your keeper.

Keeper runs across hurdles facing straight ahead which forces a rotation to face the ball.

Start with easy throws to allow for success and then progress to low, bouncing, high throws asking for full extensions and increased leaping requirements. If you can, set this up at two goals so that you can reverse direction after each turn. Otherwise do three sets going one way, reposition the cones and do three sets the opposite direction.

Coach's Notes



Fitness Drill # 5: Run - Jump - Crouch - Throw

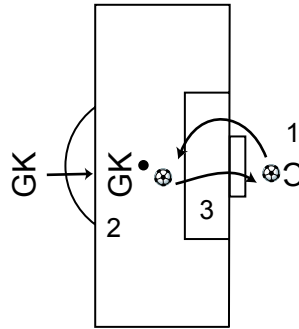

1. Coach throws ball in a high arc from behind the net over top of cross bar. The ball should be aimed to come down between the 6 yd box and the penalty spot.
2. The GK waits for the throw at the top of the 18 yd box. When the ball is thrown, GK runs towards it and jumps high to catch ball at it's highest point, one knee up.
3. After GK catches ball, GK in one continuous motion goes down to a crouching position, then jumps up and throws ball back over cross bar to coach.

Coaching Points/Progression

It is important for the coach or server to get a lot of height on the throw to allow the keeper time to run under the ball and get as high a vertical leap as possible.

Coach can start the throw for the ball to be closer to the keeper initially, or allow the keeper to start closer to the goal. Then progress to longer run ups for the keeper.

It is important to train the keeper to time their run and jump to catch the ball at the highest point possible. The second key point is for the keeper to smoothly drop into a low crouch after the catch and immediately jump back up. This build leg strength.

allow keepers to stop, stretch or shake out the legs between repeats.

Coach's Notes



Fitness Drill # 6: Sideways Hop & Dive

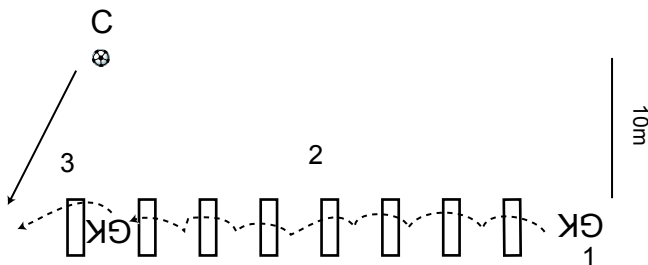

1. GK stands sideways to a series of evenly spaced hurdles, facing towards coach.
2. GK hops sideways, both feet up together, across hurdles.
3. GK dives over last hurdle to save the ball thrown by coach.

Reverse direction, 5-10 times each way, giving GK time to stretch/shake legs out in between.

Coaching Points/Progression

Have high enough hurdles or obstacles to ask the keeper to jump high and especially get well off the ground and extended for the dive.

Start with easy throws for easy catches and progress the difficulty of the save by throwing harder, lower/higher, and further away from the keeper.

You can vary the drill by asking keeper to shuttle step over the hurdles or use any stepping technique you like.

Coach's Notes



Fitness Drill # 7: Sprint - Jump - Dive

1. GK sprints through cones (slalom)
2. After the last cone, GK gets in ready position and
3. dives to save ball thrown by coach.

GK sprints back and repeats - 10 sets.

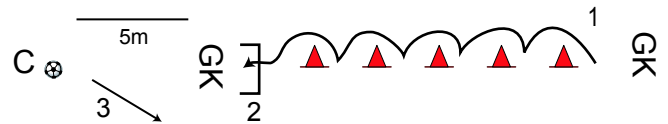
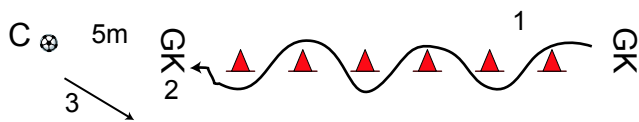

1. GK jumps over a set of cones/hurdles, feet together.
 2. After the last cone, GK crawls under a hurdle gets up into ready position and
 3. dives to save a shot from the coach.
- GK sprints back and repeats - 10 sets.

Coaching Points/Progression

Drill 1:

GK runs through cones forcing body rotation and change of direction. You can vary to ask GK to side step through cones for the last 5 sets. By varying the distance between coach and GK you can change the nature of the save. Closer in requires GK to crouch low and make a reaction or reflex save. The ball needs to be thrown to be within reach of the keeper. Further away allows keeper to set more upright and hence facilitates a throw further away from the keeper for a more extended save. Simulate possible game situations.

Drill 2:

The same points from drill 1 regarding varying distance and save apply. If you have no hurdle for keeper to crawl under, just ask them to crawl on the ground through a small goal made with cones. The lower the height of the hurdle, the more challenging for the keeper and the better the agility training. Progress by asking GK to recover and save a second ball thrown the opposite direction.

Coach's Notes



Fitness Drill # 8: Balance - Sprint - Dive

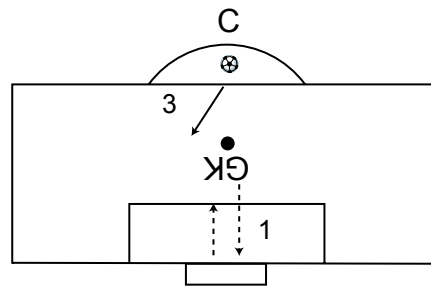

1. GK starts at penalty spot with back to goal.

GK runs backwards to goal line and bends down to touch the goal line.

2. GK sprints to top of 6yd box and gets set.

3. GK saves shot from top of penalty box.

Coaching Points/Progression

GK backwards run are small steps done as quickly as possible. Challenge keeper to see the goal line before changing direction and sprinting forward. This trains vision and reaction speed.

GK should sprint out as fast as possible and set in a crouching height appropriate for the distance of the shooter.

The shots should be varied from right at the keeper to low and wide, high and wide, and even attempted chips over top of the keeper.

Ask the keeper to make a second effort to get control of the ball after giving up a rebound.

Vary by changing angle of shooter to goal forcing the keeper to run back from goal at the right angle.

Coach's Notes



Fitness Drill # 9: Triple Dive - Recovery - Dive

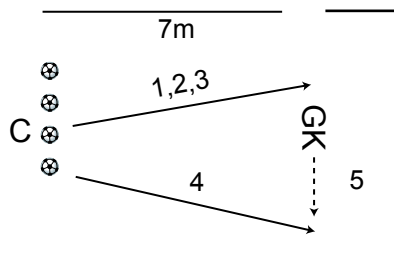

GK is kneeling in the center of the goal, facing the coach.

Coach rolls ball (1) to the right of the GK. GK dives to side, gets ball, throws ball back to coach, and returns to kneeling position. Repeat rolling two more balls (2,3) to the same side.

After the third ball, coach throws the last ball (4) high to the opposite post of the previous rolls. GK now jumps from kneeling position (5) and dives to make a save. Do 3 sets on right and 3 on left side.

Coaching Points/Progression

Vary rolls of the ball to force collapsing as well as extension dives. GK should throw ball back to coach as they are coming back up to the kneeling position - all one fluid motion.

For the 4th ball and the diving save, GK needs to pop up from kneeling position and transition into the dive right away - again in one fluid motion. If this proves to difficult initially, allow keeper to get up from knees and set in a low crouch, then throw the ball for the save.

Progress the throws from easy, mid height, low paced to low/high balls with pace thrown just inside the goal post.

Allow keeper time to recover and stretch/shake legs between sets.

Coach's Notes



Fitness Drill # 10: Rapid Fire

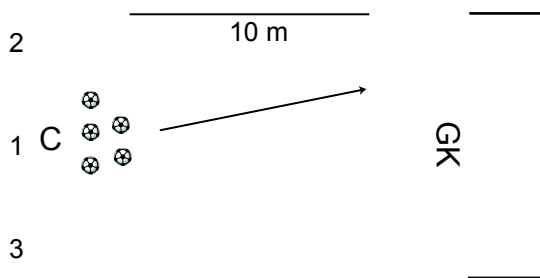

Coach has five balls and throws them at the goal from position (1).

GK Takes proper position (angle, distance) and saves each throw.
As soon as GK has recovered from a save, the next ball is thrown.

Repeat with five balls from positions (2) and (3).

GK needs to recover very quickly after a save.

Coaching Points/Progression

It is important for coach and keeper to coordinate the distances to simulate game situation. From this distance in a gam, the keeper would likely be 3-5 m off the goal line. If this is where you agree to position the keeper, then it would not be fair for the coach to throw high lobs over the keepers head. Throws should be hard and straight at the net at varying heights.

You can vary this drill by adjusting the keeper's distance from goal.

The key is for the keeper to recover quickly, get reset, and save again -

this is a FITNESS drill !!

Coach's Notes

Goalkeeping

Tactical Drills



Tactical Drill # 1: Breakaways

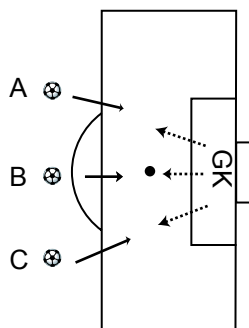

A, B, C take turns dribbling on goal.

GK starting position is 3m off goal line. GK waits until attackers are at top of penalty box.

GK then comes out in a crouching position cutting attackers angle to goal.

GK keeps eyes on ball and gets in "set" position between the 6yd box and penalty spot.

GK waits for move and dives at ball at attackers feet or saves a shot.

Coaching Points/Progression

Stopping breakaways is a bit of an individual skill for the keeper as there are many ways to play them. The key coaching points common to all techniques are:

1. React to the shooter's moves, do not anticipate (getting faked by body moves, footwork).
2. Move forward and set, never backtrack once a decision has been made to move out. Backtracking puts the keeper off balance and make it easier to score.

Some keepers like to come out early and make their bodies as big as possible by spreading arms and keeping body fairly upright.

Others prefer to delay the run out to reduce the shooter's decision time for the shot or move on the keeper. Some prefer to come out fairly upright and then crouch low as they set - keeping arms close to body to be able to react to shots close to the keeper. You and your keeper need to determine what works best and then perfect the technique through repetitions.

Coach's Notes



Tactical Drill # 2: Setting Up a Wall

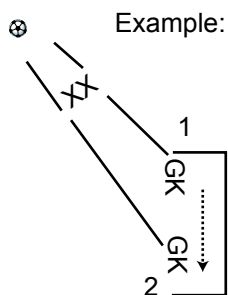

1. GK stands at near post and looks in a straight line at ball. GK directs wall such that the outside player is in line with ball, just blocking GK view of ball.
2. GK then moves towards far post until GK sees ball around inside player of wall.

Coaching Points/Progression

In modern soccer more and more goals are scored from direct free kicks. The theory is that this is due to the new style of balls with more dynamic flight patterns coupled with new shooting techniques allowing the ball to get over the wall and then dip fast into the net.

The basic principles of setting up a wall have not changed. The closer to net the more players in the wall, the further out the fewer. Typicall you start with one player in front of the ball from 35 m out and adding a player for every 5 m closer to goal, having about 5 players at the top of the box. You can use less if the kick is from the side of the net because it likely will be a cross vs a shot and marking attacking players is more critical.

The keeper's position used to be at the far post because that is where the shooters would bend the ball towards. With players' ability to hit the near post with a dipping shot, keepers need to decide if they want to be more centrally. They still need to see the ball at all times to react to the shot.

Coach's Notes



Tactical Drill # 3: Corner Kicks

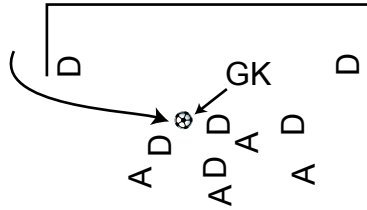

1. GK stands 2-3 steps off the goal line.
2. GK is positioned between center of goal and 3/4 way to far post.
3. GK positions defenders at posts and to mark attackers.
4. If GK has clear path to ball, GK attacks ball, jumps with one knee up to catch ball or punch it out with one or both fists.
5. If GK has no path to the ball, GK plays angle to ball and prepares to make a save.

Coaching Points/Progression

The strategy to defend corner kicks is a team/coaching choice, not the keepers. You need to decide if you want defenders at none, one, or both posts. This decision will affect the position of the keeper. With nobody at the posts, keeper needs to more central, with one player at the post keeper needs to be closer to the unattended post. The keeper needs to be ready for the counter-move by the opponent. For example, if there is nobody at the near post and the keeper is closer to the near post, the corner may be delivered to the far post to get an attempt at goal as the keeper is repositioning (as opposed to being set). Repositioning may be difficult by opposing players blocking the way. □

The biggest decision the keeper makes is if they will come out of goal to catch or punch out a high cross. The keeper must see a clear path to the anticipated point of catching the ball and, once committed, must come out to make contact with the ball. Typically goalies should be able to get to the ball inside the 6yd box (between the posts). Anything further makes the keeper more vulnerable and leaves the net unattended.

Coach's Notes



Tactical Drill # 4: Pass Backs

1. From center of field, D plays ball to GK stronger foot (right is shown) to side of goal.
2. Once GK knows where ball is going, GK quickly moves to receive ball.
3. Without pressure, GK can play ball long or pass it on 2nd or 3rd touch. GK then returns to center of goal.

If D has ball on either side of field, then D plays it straight back to same side of goal

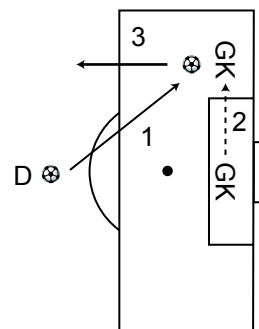

Coaching Points/Progression

Pass backs are an emergency measure when defenders are under pressure without any passing options. Some pass backs are part of a slow build up strategy and occur without pressure.

There are many ways, some risky, to play pass backs. The keeper's ability to play the ball with feet is one determining factor, the speed of opposing forwards attempting to put direct pressure is another. We recommend to consider:

1. Within the defending third, always pass back to the side of the goal.
2. As much as possible, pass the ball back to the strong foot of the keeper so they can clear the ball on their first touch if necessary, without requiring touches to move the ball from one foot to the other.
3. If there is any threat from an opposing player, clear the ball on first touch as deep as possibly - do not dribble it around inside the box.

Make sure you keeper and defenders/players know how to react to different situations.

Coach's Notes



Tactical Drill # 5: Goal Kicks

Goal kicks can be taken from any spot on the 6yd line, regardless on which side of goal the ball went out.

This is a tactical opportunity to change the side of play for the kicking team.

Goal kicks can be taken short to an open defender to build an attack or very deep into the other half.

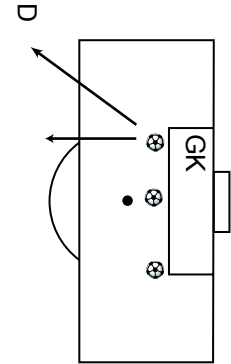

Coaching Points/Progression

How to play a goal kick is based on the team strategy and tactical direction provided by the coach. The keeper's role is to read the play and decide which tactical option to implement. If necessary, the keeper can direct team mates to move into the proper positions.

Keepers need to deliver the ball accurately and with the right pace. This is where leg strength developed in other drills is important. Passing skills can be developed by keepers running some of the passing drills in our other practice books, or by participating in team passing drills.

Coach's Notes



Tactical Drill # 6: Crosses

GK needs to change position relative to where the ball is crossed from.

If ball is near goal line (X1) GK1 plays it like a corner kick and positions closer to near post as ball approaches the goal.

As the ball moves away from line and closer to goal, GK comes towards ball to cut the angle (X2/GK2)

GK must play shot first, be ready for cross.

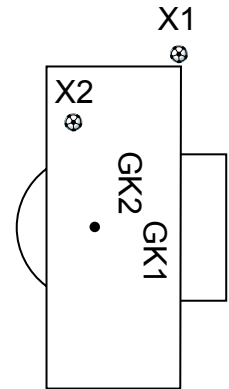

Coaching Points/Progression

The keeper needs to be mentally ready and physically positioned to react to either a cross or a direct shot on goal. Nobody can be prepared for both at the same time. The closer to the goal line and the further away from goal the opponent with the ball is, the more the keeper can decide to play a cross. As the opponent moves away from the goal line and/or decreases distance to goal, the more likely a direct shot becomes. The keeper needs to decide at which point a shot is more likely and then position themselves for a shot. If they do this and a cross is played, the keeper needs to pivot and get set for a shot from where the new position of the ball.

Whether or not a shot is more likely also depends on the number and position of the defenders. The more they block a shot, the more likely a cross becomes.

This is where the pivoting drills as well as the game situation drills train the keeper.

Coach's Notes



Tactical Drill # 7: Wide Distribution Throws

Attackers play 6v6 in one half.

1. A starts play with a long ball into the penalty box.
2. GK comes out and catches ball, being pressured by attackers. GK throws a long ball towards one of the small wide goals at the center line. At the same time a defender sprints to receive the ball thrown by GK.

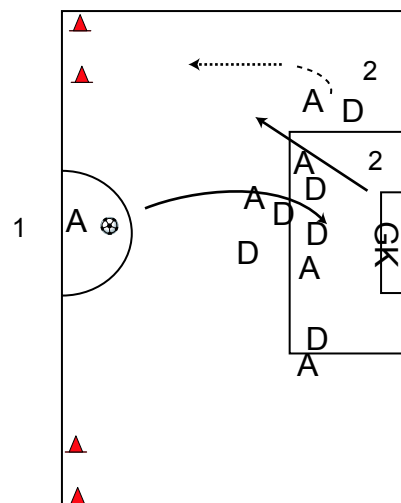

Coaching Points/Progression

The attackers put light pressure on the keeper to distract them, but allow keeper to cleanly get to the ball. This is a distribution drill, not a "control the box" drill.

As soon as keeper has control of the ball, two players must break wide towards the small goals positioned at the half line.

Keeper must throw the ball ahead of the breaking players.

Try various distances of the throws to work on accuracy and determine the strength of your keeper. Younger keepers may not have the range and you may not wish to do this in a game situation. Keepers need to develop upper body strength and proper throwing technique, either a motion from the side of the body or an overhead or angled overhead throw. You want to get some videos from pro goalies for your keeper. Push-ups are a simple way to develop upper body strength.

Coach's Notes



Tactical Drill # 8: Penalty Kicks

There are two main theories about saving penalty kicks:

1. Guess the corner of the shot and dive there as the shooter is about to strike the ball.
2. React to the kick by:
 - a. keeping eye on the ball.
 - b. as shooter approaches ball, the shooter's planting foot comes into the GK's vision.
 - c. GK looks at direction of planting foot just before kicking foot strikes the ball. Ball will likely go into direction in which the planting foot is pointing.
 - d. GK sees ball move and immediately reacts to shot.

Coaching Points/Progression

The choice of either of the two basic strategies above is just one component of saving penalty kicks. Just as critical, if not more critical, is the psychological aspect of the penalty kick.

We believe in one key principle:

THE PRESSURE TO SUCCEED IS ON THE SHOOTER - NOT THE KEEPER. SHOOTERS EXPERIENCE MORE FEAR, NERVOUSNESS AND ANXIETY THAN KEEPERS.

Your keepers must believe this. They need to approach the penalty kick with confidence, showing the shooter that they BELIEVE they will stop the shot or that the shooter will miss. Some keepers like to distract shooters by walking towards the ball, talking to the shooter, or jumping with arms flailing prior to the shot. Others simply get in goal, stare at the shooter and then focus on the shot.

Coach's Notes



Tactical Drill # 9: Organizing Play

The goalkeeper is ideally suited to organize the entire team because GK has the vision of the entire field.

Play a half field game using 6 attackers against the GK and 4 defensive players. Attackers always start with the ball.

GK must tell defenders whom to challenge and whom to mark. Coach stops play at random and awards the attacking team a free kick. GK sets up wall and positions defenders.

Coaching Points/Progression

The more advanced your team and the more experienced your keeper, the more relevant it is for the keeper to organize the play. To do this, keepers need to understand the game plans, strategies, and tactics. They need to know the roles of each player in the system. They also need to know the strengths and weaknesses of their team mates so they don't instruct them to do things that puts them at risk. Keepers must communicate briefly, concisely, and clearly to avoid confusion. Their team mates must have confidence that the keeper knows what they are saying and must recognize them as a leader, if not the coach's tactical extension on the field. This will take quite some time to develop.

Besides running this drill, we recommend for the coach to include keepers in all tactical discussions and have extra discussion if there isn't opportunity during practice. Also, reinforce this role during every practice scrimmage or drill involving game situations. Monitor the keeper during competition and have feedback discussions. If this works well, it's like an extra player on the field.

Coach's Notes



Tactical Drill # 10: Long Balls

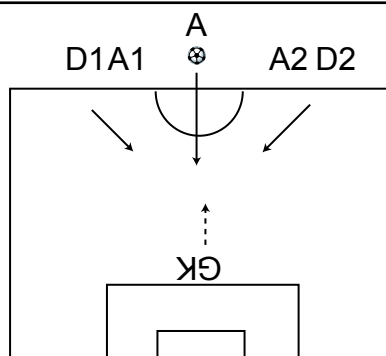

A plays a long ball to goal. A1/D1 and A2/D2 chase ball in. GK starts near top of penalty box, sprints out and clears ball into other half.

If GK cannot get to ball before A/D pair, then GK retreats to 6yd box and defends the A v D game.

Coaching Points/Progression

The keeper's distance away from the goal line depends on where the ball is. keeper must avoid being surprised by a long arcing shot over top of the head. We recommend keepers to be at the top of the penalty box when the ball is in the other half, up to the half line. As the play comes into the keeper's half, keepers stay further back.

The key decision by the keeper on a long ball in is "can I get to the ball first?". If the answer is yes, then the keeper goes for it and clears the ball. If the answer is no, then the goalie quickly retreats to the top of the 6 yd box or further back and gets ready to play a breakaway on goal.

In this drill, vary the angle of the initial pass and the angle of the long ball in. Ask the pairs chasing the ball to vary their aggressiveness giving the keeper different scenarios to look at.

If there are any questions about the keeper's decision and play, have a quick discussion.

Coach's Notes

Goalkeeping

Scrimmages



Scrimmage # 1: 4v4 from two Sides of Goal

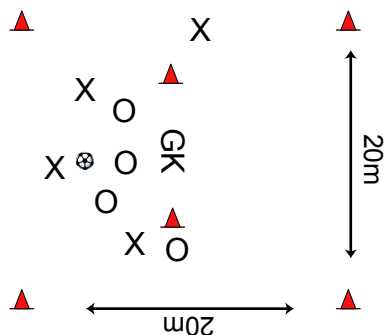

X play 4v4 against O. Teams can score from either side of goal.

Emphasize quick passing and shots as well as quick switches to other side of goal forcing GK to turn around quickly and get set for new shot from new angle.

Coaching Points/Progression

This also serves as a great goal scoring drill for the team, consider getting your starters engaged in the exercise and ask them to play at regular game intensity.

Encourage lots of shots - remember the field of play is much smaller than the penalty box.

Encourage lots of switches from half to half forcing the keeper to pivot in goal and readjust their angle.

For progression purposes you can reduce the size of the field OR add a second ball.

Observe the keeper and help if necessary by reminding of proper crouch position relative to the distance of the ball and encourage them to challenge the shooters. Do not let your keeper to be passive and stand waiting for a shot.

Coach's Notes



Scrimmage # 2: 4v2 in Penalty Area

GK starts play by throwing a ball to an attacker (X).

X must get players into shooting positions quickly and take shots from any angle and distance.

Have balls available for GK to restart play quickly after a shot.

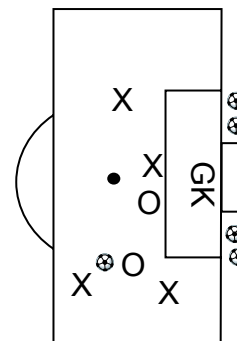

Coaching Points/Progression

Keeper always plays angle to ball and comes out to challenge the shooter. This will provide the attacking team with opportunities to pass to an open player thus putting the keeper completely out of position. That is exactly what you want from this drill. It will force the keeper to quickly adjust position to challenge the new shot with a new angle. Also, if attackers take a quick shot after putting the goalie out of position, then the keeper will have an opportunity for a reaction or reflex dive. This puts to use many of the techniques you have trained so far.

There will likely quite a few situations where the keeper will deflect a ball back into play. This requires the keeper to quickly recover and get reset.

Do not allow your keepers to stay on the line and be passive or to give up after a save.

Coach's Notes



Scrimmage # 3: 4v2 or 1v1

X play 4v2 against O outside the penalty box.

X set up a shot from outside or pass the ball into the area to another X making a run to play 1v1 on GK.

Encourage lots of shots and mix with 1v1.

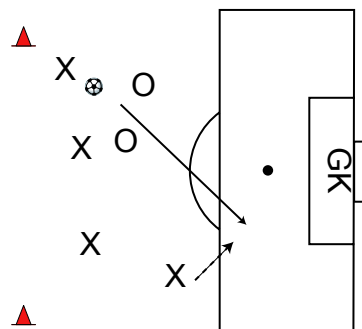

Coaching Points/Progression

The key point here is for the goalie to be alert and adjust their position relative to the ball constantly. As the ball is outside the penalty box, the keeper can be a few steps off the line. It is recommended that when the ball is near the top of the box, the keeper stays one or two steps maximum off the line.

Keeper also needs to shift sideways to play the proper angle to the ball. A rule of thumb is to have the keeper be in a straight line between the ball and the center of the goal.

Experience will train proper positioning to the point where it must be intuitive.

If you feel the keeper is not in an optimal position, freeze play and have the keeper stand behind the ball and a player stand where the keeper was. This gives the keeper a perspective from the shooter's position and may get him to adjust better in the future.

Coach's Notes



Scrimmage # 4: 3v3 on Two Goals

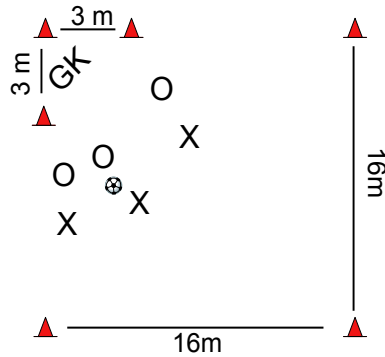

Make two 3m wide goals adjacent to each other in the corner of the field.

One GK covers both goals.

X and O can score on either goal.

Coaching Points/Progression

The keeper is challenged to clearly be in one of the goals to protect it against a shot. The attackers will spot this and try to take a shot on the open goal. This is what you want. It forces the keeper to focus on one goal but train themselves mentally and physically to react to a different situation. This should force some quick foot work by the keeper as they constantly adjust position and pivot to save a shot on the open goal.

Depending on the success of the keeper or the shooters, adjust the size of the goals to give the keeper a fair challenge.

Coach's Notes



Scrimmage # 5: 3v3 with Two Balls

Play 3v3 in the penalty box using 2 balls.

X and O can both score on goal.

GK needs to decide which shot to play based on the most dangerous position.

Teams are encouraged to shoot at any opportunity.

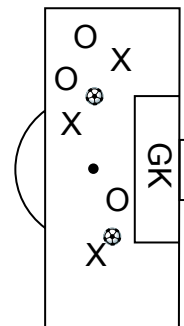

Coaching Points/Progression

This drill will initially cause confusion amongst the teams playing the 3v3, particularly if a player from each team is in possession of a ball. Their team mates will be torn between challenging the player from the opposing team and getting in position to receive a pass from their own player. Step in and encourage them to use potential inaction by the opponent to shoot on goal. the more shots the better.

Keepers will be torn about which ball to defend. This may freeze them in a spot where they can't stop either shot. They need to decide which ball is the most dangerous and then stay with that ball. At the same time they need to use their peripheral vision to see if the other ball is moving in a more dangerous spot. they then need to shift position and defend it.

A safe initial strategy for the keeper is to stay with the ball they were defending until it no longer appears dangerous and not to worry about the second ball in the mean time.

Coach's Notes



Scrimmage # 6: Crossing and 4v2 in the Box

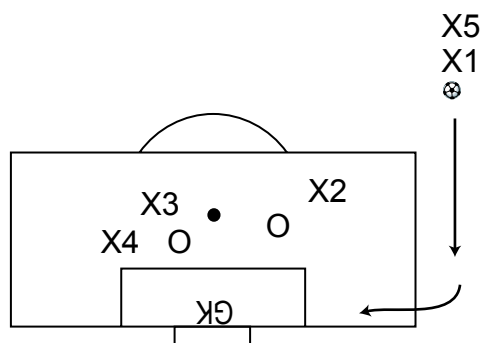

X1 dribbles ball towards goal line and crosses it into box.
X1 then joins three other X and plays 4v2 on goal.

GK decides to catch crossed ball or stay in goal.

When play is done, X5 crosses and X4 takes spot of X5.

X's vary from where they cross ball

Coaching Points/Progression

The keeper needs to decide whether or not to come out and pick off the cross. If they come out, keeper needs to make contact with the ball and either catch or clear with a punch out. If keeper decides to stay in goal then they need to set and play the proper angle for a shot or header.

Encourage the players crossing to vary their cross from low driven crosses to high crosses to far post and to drop at various distances between the 6yd line and the penalty spot.

keepers need to train to play low driven crosses like a shot and dive outward (toward penalty spot) to save the ball.

Coach's Notes



Scrimmage # 7: 4 x 1v1 in Penalty Box

X1/O1, X2/O2, X3/O3, X4/O4 play four 1v1 games in the penalty box.

Players try to take as many shots as possible.

GK sets to play the most dangerous shot and constantly adjusts with the play.

Mix up pairs every 2 minutes.

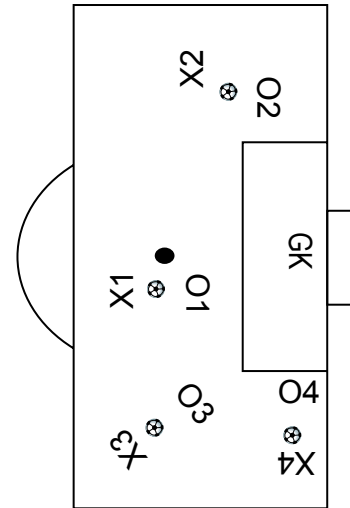

Coaching Points/Progression

This is an extreme challenge for the keeper. You may choose to start with two balls and play 2 x 2v2. Once you progress to 4 x 1v1 it is important for the keeper to pick the most dangerous/closest pair and play the shot.

After a save or attempted save, the keeper needs to recover quickly to get ready for the next shot at goal.

Ask the pairs not to shoot until the keeper has recovered from the previous shot.

Coach's Notes



Scrimmage # 8: GK in 1v1

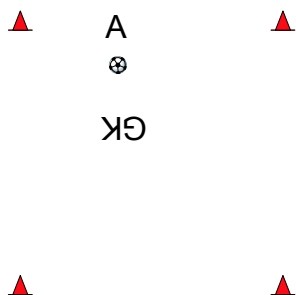

A plays 1v1 against GK in a 10m x 10m grid.

A scores a point by dribbling the ball over any side line.

GK scores point by taking ball away from A by diving on ball and getting control with the hands.

Coaching Points/Progression

Attacker cannot attempt to cross the same goal line of the square twice in a row. They must choose another goal line.

Keeper needs to stay close to attacker and focus on the ball. If the keeper is on the line that is being attacked, keeper needs to crouch low and keep eyes on the ball. They need to be ready to dive on the ball leading with the shoulder when the attacker makes a move and the ball is moved further away from the attacker's body, i.e. a slight loss of control by the attacker.

if the attacker turns for a different goal line, that may also be a moment to dive at the ball. If not, then keeper has to quickly chase the attacker to the other line and potential dive on the ball from a side angle without committing a foul

Coach's Notes



Scrimmage # 9: 4v6

On a field twice the size of the penalty box, A play 6v4 vs. D.

As try to score. After D gains possession they must pass the ball to a player D making a run outside the field.

Play then restarts with As.

GK must organize defenders and provide clear instructions on challenging & covering.

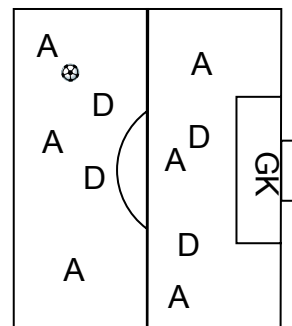

Coaching Points/Progression

The key point of this drill is for the keeper to read the play and provide instructions to the defenders. They need to call players by name and be specific which player (by number or name) to challenge and to shout out who needs to cover/mark which attacker.

At the same time the goalie must shift with the play and be ready to save a shot or play a cross.

If the attackers are struggling due to the effectiveness of the defenders, then remove a defender and play a 3v6.

After losing possession, attackers need to pressure the defender with the ball to quickly regain possession and get a shot on goal.

Coach's Notes



Scrimmage # 10: 2v5 in Penalty Box

5 attackers v 2 defenders play freely inside the penalty box.

Attackers must set up and get as many shots as possible.

They need to move quickly forcing GK to move with play and adjust position.

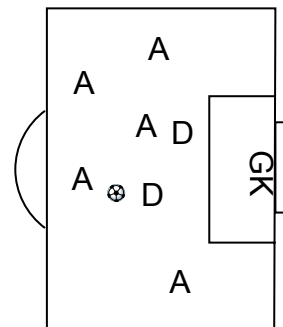

Coaching Points/Progression

Keeper needs to make sure one of the defenders always challenges the ball and the second defender covers (provides support) and cuts off passing lanes.

This drill should result in many quick passes forcing the keeper to shuttle with the changes of direction of the attack and set into the "ready" position fast.

Reflexes will be trained and it is through this repetition that the keeper gains intuitive experience on angles and proper position.

Stop play and have keeper analyze their position if you think it is not optimal and the keeper had the time and opportunity to adjust.

Coach's Notes