

# **YOUTH FOUNDATION**



## **Print & Go Practice Plans and Drills**

**basic skills and tactics**

an essential guide for all youth soccer coaches

**World Cup 2010 (2nd) Edition**

written by best selling soccer author Tom Sauder

## TABLE OF CONTENTS

Acknowledgement	4
Introduction	5
Our Philosophy	6
Usage Recommendations	7
Practices Summary Matrix	8
Season Practice Sequences	9
<u>Print &amp; Go Practices</u>	<u>10</u>
· # 1 Shooting, Ball Control, Flank Attack	11
· # 2 Moves, 1v1	12
· # 3 Shooting, Speed, Change of Direction	13
· # 4 Shooting, Reaction, Scoring	14
· # 5 Passing, Dribbling, Shooting	15
· # 6 Flank Attack, Shooting, Anticipation	16
· # 7 Defending, Agility, Speed	17
· # 8 Moves, Passing, Transition Play	18
· # 9 Moves, Shooting, Flank Attack	19
· #10 Moves, Passing, Reaction	20
<u>Warm-Ups</u>	<u>21</u>
· # 1 Dribbling, Receiving the Ball	22
· # 2 Change of Direction, Moves	23
· # 3 Dribbling, Moves	24
· # 4 Dribbling, Receiving, Reaction	25
· # 5 Dribbling, Overlap Passing, Reaction	26
· # 6 Anticipation, Dribbling	27
· # 7 Agility, Dribbling	28
· # 8 Moves #1	29
· # 9 Moves #2	30
· #10 Moves, Reaction	31
<u>Technical Skills</u>	<u>32</u>
· # 1 Change of Direction, Dribble and Shoot	33
· # 2 Change of Direction, Cut Backs	34
· # 3 Dribble and Shoot #1	35
· # 4 Dribble and Shoot #2	36
· # 5 Overlap Runs with 2v1, scoring	37
· # 6 Pass and Shoot	38
· # 7 Defending 2 Goals	39
· # 8 4 v 2 Passing	40
· # 9 Dribble and Shoot #3	41
· #10 3 v 6 Defending	42

## TABLE OF CONTENTS

<u>Fitness Drills</u>	<u>43</u>
· # 1 Run-Sprint-Shoot	44
· # 2 Cooper Test Run	45
· # 3 Change of Direction Sprints	46
· # 4 Reaction Sprints	47
· # 5 Reaction Dribble and Sprints	48
· # 6 Sprints, 1 v 1, Shoot	49
· # 7 Pass, Turn, Sprint, Pass in rectangle	50
· # 8 Pass, Turn, Sprint, Pass in Straight Line	51
· # 9 Jump and Shoot	52
· #10 2 v 2 + N, Fast Break	53
<u>Tactical Drills</u>	<u>54</u>
· # 1 Flank Attack with Switching Play	55
· # 2 1 v 1 with Change of Direction	56
· # 3 Fast Break Attack	57
· # 4 Fake Defender and Shoot	58
· # 5 3 v 3 Penetration, Passing, Shooting	59
· # 6 Flank Attack #1	60
· # 7 Defending 1 v 1	61
· # 8 Transition Play	62
· # 9 Flank Attack #2	63
· #10 Pass and Follow	64
<u>Scrimmages</u>	<u>65</u>
· # 1 4 v 2 on 2 Goals	66
· # 2 3 v 3 on 2 Goals	67
· # 3 4 v 4 on 4 Goals	68
· # 4 4+GK v 4+GK on 2 Goals	69
· # 5 4 v 4 on 4 Goals w.GK	70
· # 6 6 v 4 with GK on 3 Goals	71
· # 7 4 v 2, no Goals	72
· # 8 5+GK v 5+GK on 2 Goals, ½ Field	73
· # 9 6+GK v 6+GK on 2 Goals, ½ Field	74
· #10 3 v 3 on 4Goals with GK	75

## ACKNOWLEDGEMENTS

This book is dedicated to all coaches, players, parents and officials without whose passion for soccer the greatest game in the world could not exist.

We thank all the teams, players and coaches that have participated in developing the practice sessions and used them on the field to make sure they work.

## Introduction

The idea for Print & Go practices came from a recognition that something was missing for soccer coaches amongst all the training materials and resources available.

No doubt you have heard that a coach must have a practice plan when going to run a practice. If you are like most coaches, you probably have books and videos full of drills and practice ideas. If you are like most coaches, you also rush from work to the practice field desperately trying to write a practice plan in your head (hopefully not on paper while driving), organizing and visualizing drills and things to say. Maybe you even brought some books or photocopies of drills with you. Maybe you even roughed out a plan the night before on a piece of paper. No matter what, you either spent significant time researching and writing or significant time scrambling.

What about the next practice? What about a season plan? What about the team's needs and focus? Fitness training: yes or no? During practice or separate sessions? Scrimmages? Speed and mental training? Where are the drills for that? How about flexibility? Any difference between age groups?

To help you focus your time on deciding what is important for your team to work on we thought it would be a good idea to do the research and the writing for you. So we have developed a set of 10 complete practice sessions and a tool to develop hundreds of additional sessions. All you need to do is to decide on a focus for the season and a theme for each practice. The printed material is supplemented by pictures of stretches and moves and by the tips published on our website [www.soccerpracticebooks.com](http://www.soccerpracticebooks.com).

This is the first in hopefully a series of Print & Go practice sessions and PracticeBuilder tools.

We recommend this set for youth teams (9 and older) up to and including School teams.

These practices and drills have been run with 9-12 year old boys' and girls' teams. They can be used for recreational entry level teams at older ages as well.

We hope you will enjoy your season.

## Our Philosophy

Practices need to be fun for players and coaches. Drills must be interesting and vary across skills, tactics, strategies, mental and physical fitness and team building.

Players need to be busy with a ball at all times to maximize the number of touches they get with the ball.

Practices must flow and time must not be wasted by the coach setting up or thinking about drills.

Practices and drills must have a purpose.

We suggest you schedule 2 hours for the practice with the hope to start 15 minutes after the scheduled start time and allowing for breaks. That way, the 1-1/2 hour sessions will fit nicely without the stress of late-comers messing things up. If the practice starts on time and flows well, use any extra time at the end for additional scrimmages. You will be very popular with the players.

We suggest that each practice starts with a brief meeting between coaches and players in which the theme of the practice is communicated to the players.

Then start with a warm up. You will notice that our warm-ups already incorporate the theme of the practice, lots of ball work, fitness and thinking exercises in a purely soccer way. No repetitive running, not many exercises without a ball and if so, then they are fun and challenging.

We have cushioned the fitness section between technical and tactical drills. The reason is that we want players to be properly warmed up for skill work, but then challenge their stamina and mind by requiring technical skills after fitness work.

End with a scrimmage and feel free to adapt them or change them to suit your team's needs.

After the practice, have a quick meeting again for going over the practice briefly, invite comments from the players, congratulate them on their effort and improvement and make any announcements regarding upcoming events.

During the drills, be patient. Observe and intervene only when needed. Keep your comments positive, to the point and brief. Speak loudly and clearly. It is better to demonstrate a drill or a concept than to give a speech. Never yell at a player or use derogatory language.

All drills are designed to be conducted on ½ field, but most can be expanded to full field if space is available. This would be particularly true for full field scrimmages.

## Print & Go Practices - Usage Recommendations

We have developed a matrix for the 10 sessions showing the focus of the practice and of each of the drills in the practice. Please study the matrix to become familiar with the content of each session and drill.

On the matrix page is a box suggesting various ways to sequence these sessions. Chose the emphasis for your next 10 practices (which could be a season or pre-season) and study the sequence suggested. Of course, you are free to develop your own sequence. Refer to the individual practice sheets or the individual drill sheets for a better understanding. Write comments on the drill sheets.

We suggest you visualize the drills to make sure you understand how they will flow. If necessary, set them up in your living room and walk through them.

Keep a clean copy of the book at home and put the pages you take to the practice with you in clear plastic sheet protectors to protect them from water or other disturbances (you know what can happen to papers).

Each drill page comes with helpful coaching points to make the drills work for you and your team. We also offer suggestions on drill modifications to either challenge your players, or to reduce the challenge to increase success for the kids.

We recommend that you stick with our general practice philosophy and at a minimum suggest you start with a warm-up and end with a scrimmage. In between, you can design whichever way.

This book is provided or sold on an as is basis without warranties of any kind, express or implied, including but not limited to those of title, merchantability, fitness for a particular purpose, or non infringement, or any warranty arising from a course of dealing, usage, or trade practice. The user assumes all responsibility or risk for the use of this practice book and the drills. contained therein. Under no circumstances, including negligence, shall any of the parties involved in creating, maintaining, or supplying information used in this practice book and the drills contained therein be liable for any direct, indirect, incidental, special, or consequential damages, or lost profits that result from the use or inability to use this soccer practice book and its soccer drills.

Practice #	Practice Focus	Warm-Up Focus	Technical Drill	Fitness Focus	Tactical Drill	Scrimmage Focus
1	<b>Shooting</b> Ball Control Flank Attack	<b>Dribbling</b> Receiving the Ball	<b>Change of direction</b> dribble and shoot	<b>Run-sprint-shoot</b>	<b>Flank attack with</b> switching play	<b>4 v 4 on 2 goals</b>
2	Moves 1 v 1	Change of direction moves	Change of direction: cut-backs	Cooper test (12 min) run	1 v 1 with change of direction	3 v 3 on 2 goals
3	Shooting Speed Change of direction	Dribbling Moves	Dribble and shoot #1	Change of direction sprints	fast break attack	4 v 4 on 4 goals
4	Shooting Reaction Scoring	Dribbling Receiving the Ball Reaction	Dribble and shoot #2	Reaction sprints	Fake defender and shoot	4+GK v. 4+GK on 2 goals
5	Passing Dribbling Shooting	Dribbling Overlap passing Reaction	Overlap runs with 2 v 1 plus scoring	Reaction dribble and sprint	3 v 3 penetration passing and shooting	4 v 4 on 4 goals with GK
6	Flank attack Shooting Anticipation	Anticipation Dribble	Pass and shoot	sprint- 1 v 1- shoot	Flank attack #1	6 v 4+GK on 3 goals
7	Defending Agility Speed	Agility dribble	Defending 2 goals	pass-turn-sprint-pass in rectangle	Defending 1 v 1	4 v 2 no goals
8	Moves Passing Transition play	Moves	4 v 2 passing	pass-turn-sprint-pass straight line	transition play	5+GK v 5+GK on 2 goals 1/2 field
9	Moves Shooting Flank Attack	Moves	Dribble and shoot #3	Jump and shoot	Flank attack #2	6+GK v 6+GK on 2 goals 1/2 field
10	Moves Passing Reaction	Moves Reaction	Defending 3 v 6	2 v 2+N fast break	Pass and follow	3 v 3 on 4 goals w.GK

## ***Practice Sequence Suggestions***

### **Coaching Emphasis**

### **Practice Sequence**

Moves	8-9-2-6-10-1-3-4-5-7
Passing	5-8-10-6-1-8-3-4-7-9
Shooting	3-4-9-6-1-2-5-7-8-10
Defending	7-10-4-3-1-2-8-9-5-6
Flank Attack	6-9-1-2-3-4-5-7-8-10
Endurance	2-10-7-8-1-5-6-9-4-3
Speed	3-6-5-1-4-9-2-7-8-10
Strength	9-6-3-5-8-10-7-4-2-1
Pre-season Build	1-2-3-6-7-8-4-9-10-5

# Youth Foundation

Print & Go

Practice Plans



# YOUTH SOCCER PRACTICE # 1

**Practice Focus: Shooting, Ball Control, Flank Attack**

**Time: 1.5-2 hrs including arrival/leaving**

## Warm-Up: Dribbling & Receiving the Ball (30 min)

1. Each player dribbles a ball around field in various sizes of the figure 8 using the same foot .
2. Runners stretch (hold 20 seconds each side, 3 reps/side)
3. In pairs, 10m apart, each pair with a ball. Player throws ball to partner's head and calls "catch" or "head". Partner does opposite of command, heads ball when call is "catch" and vice versa. Alternate.
4. Quad stretch (hold 20 seconds each side, 3 reps/side)
5. In pairs, 15m apart, each pair with a ball. Partner passes ball and calls either "man on" or "turn". "man on" requires one touch pass back , "turn" requires controlling ball, turning, dribble two steps turn again and pass back to partner, calling out either command.
6. Hamstring stretch.(hold 20 seconds each side, 3 reps/side)
7. Heel stretch (hold 20 seconds each side, 3 reps/side)

## Technical Skill: Change of Direction Dribble and Shoot. (15min)

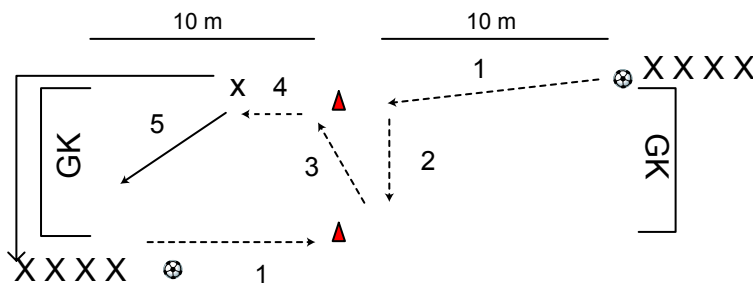

1. X dribbles ball to cone
2. X changes direction and dribbles to opposite cone
3. X changes direction and dribbles diagonally across, wide of the net.
4. X sets up shot with one last touch
5. X shoots and runs to end of opposite line

Both lines do drill at same time avoiding collision at center by looking up.

## Fitness Drill: Run-Sprint-Shoot. (15 min)

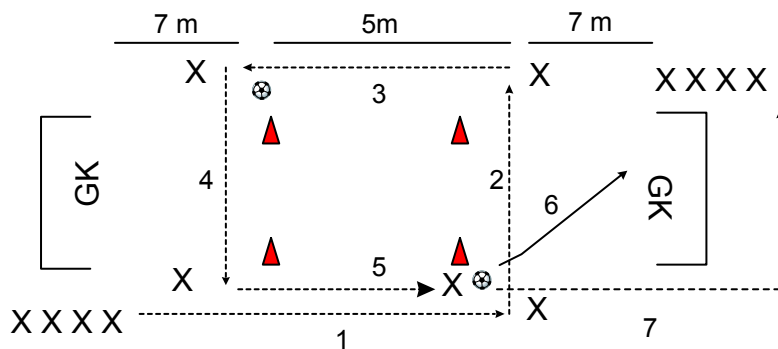

1. X half sprints to second cone
2. X sidesteps to cone across
3. X runs backwards to 4th cone
4. X sidesteps to cone 1
5. X sprints to ball
6. X shoots ball on target
7. X sprints to back of other line

Both lines do drill at same time, avoiding collisions.

Coach/helper replaces ball for next shot

## Tactical Drill: Flank Attack with Switching Play. (30 min)

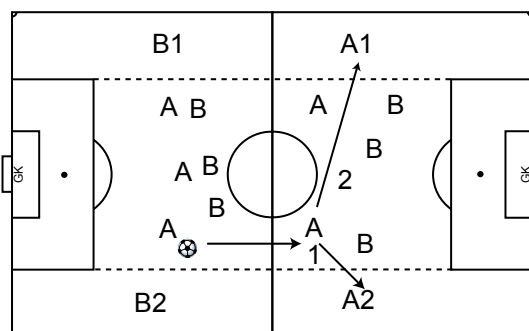

A1/A2 & B1/B2 stay in their lanes and cannot be challenged. Teams must play into a wide lane (1) before they can score. Encourage teams to switch play (2) to stretch the defense.

## Scrimmage: 4 v 4 on 2 goals. (30 min)

Choose 4v.4 small games and set up small fields. Vary rules as to number of touches ,player position, moves.etc. before goal can be scored. Or Play full field scrimmage with a particular tactical objective.

Players should be busy at all times. If drills keep players inactive, break team into smaller groups and run parallel drills.



# YOUTH SOCCER PRACTICE # 2

**Emphasis: Moves, 1 vs 1**

**Time: 1.5-2 hrs including arrival/leaving**

## Warm-Up: Change of Direction Moves. (30 min)

1. Each player dribbles a ball around perimeter of field twice .
2. Runners stretch (hold 20 seconds each side, 3 reps/side)
3. While dribbling slowly, execute scissors move (sweep right foot across front of ball and plant, take ball away with outside of left foot in opposite direction) against an imaginary defender. Alternate feet.
4. Quad stretch (hold 20 seconds each side, 3 reps/side)
5. In pairs, execute scissors move vs. passive partner. Alternate.
6. Hamstring stretch.(hold 20 seconds each side, 3 reps/side)
7. In pairs, execute scissors move vs. active defender.
8. Heel stretch (hold 20 seconds each side, 3 reps/side)

## Technical Drill 15 Min: Change of Direction, Cut-Backs

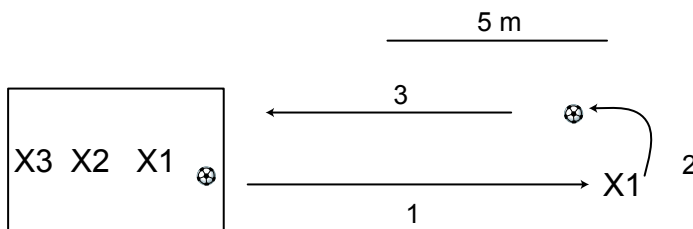

Groups of 3

1. X1 passes ball 3-5 m out and sprints after it
2. X1 cuts ball back with inside foot
3. X1 passes ball to x2 and sprints to end of line
4. X2 repeats

Ask players to execute quick turn with outside of foot and flicking straight back with sole of foot in step 2.

## Fitness Drill: Cooper Test

12 minute run around field.

Record # of laps for each player.

Depending on age and competitiveness of team, variations more suitable can be chosen. The important thing is to have players work at an elevated heart rate for at least 12 minutes.

## Tactical Drill: 1 v 1 Change of Direction. (15-30min)

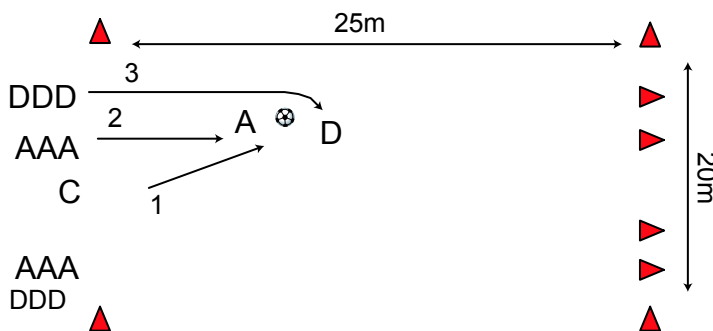

- 1.Coach (C)passes ball diagonal to either attacker A
2. A sprints to get control of ball.
3. Defender D sprints to beat A to ball or, to get goalside of A (shown).
4. A now plays 1v1 against D on either goal.
5. Either player can score.
6. A goal or coach's call ends 1v1. Players jog back around outside field to opposite line.
- 7.Coach restarts game on other side.

## Scrimmage: 15-30 min: 3 v 3 on 2 goals

1. Divide team into small teams of 3 and set up a field for each 6 players.(18 players-3 fields)
2. Play 3 v 3 in tournament format, 2 min.games.
3. Emphasize 1 v 1 moves to set up a pass or shot on goal.
4. Goals must be scored from inside opponent's half

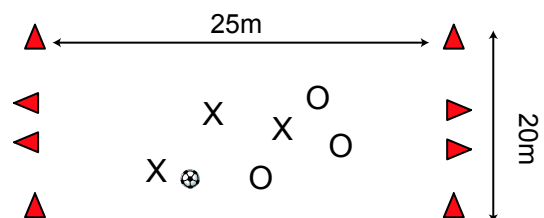

Players should be busy at all times. If drills keep players inactive, break team into smaller groups and run parallel drills.



# YOUTH SOCCER PRACTICE # 3

**Emphasis: Shooting, Speed and Change of Direction**

**Time: 1.5-2 hrs including arrival/leaving**

## Warm-Up: Dribbling, Moves. (30 min)

1. Form lines of 8 players and jog around 1/2 field. Last player weaves through line to front, etc.
2. Runners stretch (hold 20 seconds each side, 3 reps/side)
3. Tap ball 3-4 times between feet, then drag 1/4 turn to right with sole of foot. Repeat w.left/right turns on command.
4. Quad stretch (hold 20 seconds each side, 3 reps/side)
5. Dribble ball across field pushing it forward with laces, stopping with sole of foot, pushing forward, etc.
6. Hamstring stretch.(hold 20 seconds each side, 3 reps/side)
7. Repeat exercise 1 above, except each player has a ball and last player must dribble-weave to front.
8. Heel stretch (hold 20 seconds each side, 3 reps/side)

## Technical Skill:Dribble and Shoot #1. (15 min)

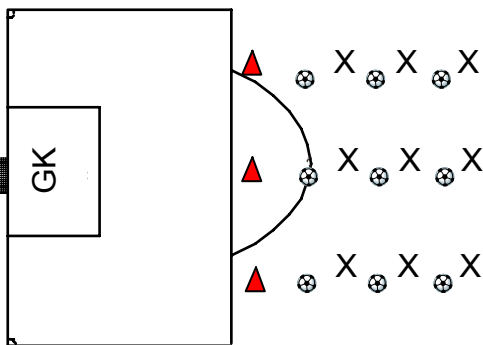

1. Dribble to cone.
2. Make a move on cone into the penalty box.
3. Finish with a shot on net with your first touch inside penalty box.

It is important to make sure that the last touch into the penalty box is diagonal and away from shooting foot to set up the shot.

If groups are too large and players stand around, set up a second/third goal with cones.

## Fitness Drill: Change of Direction Sprints. (15 min)

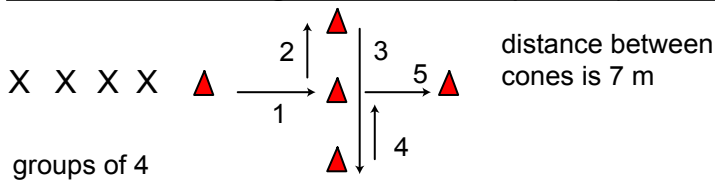

1. Player sprints from 1st to 2nd cone and makes sharp turn to left.
2. Sprints to 3rd cone, sharp reverse turn.
3. Sprints to 4th cone, sharp reverse turn
4. Sprints back to 3rd cone, sharp turn right
5. Sprints to 5th cone, turns and jogs back

## Tactical Drill: Fast Break Attack. (15-30 min)

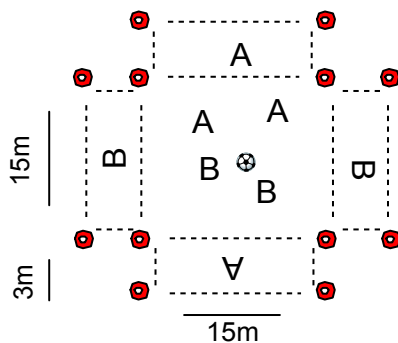

1. teams A/B play against each other inside 15m x 15m grid.
2. each team has a player in opposing 3m deep end zones.
3. players must pass into either end zone from within 2m, sprint to end zone, and stay as target player.
4. End zone player breaks out fast to start his team playing into opposite end zone.

1 pt for each successful pass. Team w. 10 pts wins.

## Scrimmage: 4 vs 4 on 4 Goals. (15-30 min.)

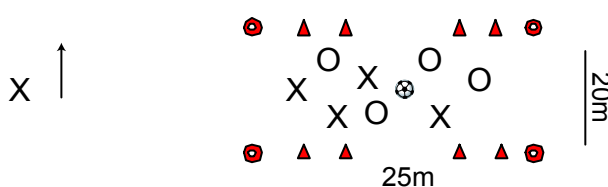

1. 4 v.4 play
2. teams score by dribbling ball in either goal in opposing end. (goals are 2m wide).
3. team that scores restarts play by playing ball in from sideline

Players should be busy at all times. If drills keep players inactive, break team into smaller groups and run parallel drills.



# YOUTH SOCCER PRACTICE # 4

**Emphasis: Shooting, Reaction and Scoring**

**Time: 1.5-2 hrs including arrival/leaving**

## Warm-Up: Dribbling, Receiving the Ball, Reaction. (30 min.)

1. Spread cones around field (2 per player) and ask each player to dribble towards a cone, change direction at cone.
2. Runners stretch (hold 20 seconds each side, 3 reps/side)
3. groups of 4:
 

X1 ⊕ → O1

X2 ⊕ → O2

}

X1/X2 tosses ball to O1/O2 who plays it back to X1/X2 with one touch.

O1 and O2 change place, X1 now tosses to O2, X2 to O1. After 2 minutes alternate and have O's throwing to X's.
4. Quad stretch (hold 20 seconds each side, 3 reps/side)
5. 25mx25 grid, each player dribble a ball. On coach's command, players exchange balls.
6. Hamstring stretch.(hold 20 seconds each side, 3 reps/side)
7. Repeat exercise 5 above, except that 2 players don't have a ball to start.
8. Heel stretch (hold 20 seconds each side, 3 reps/side)

## Technical Skill: Dribble and Shoot #2 (15min)

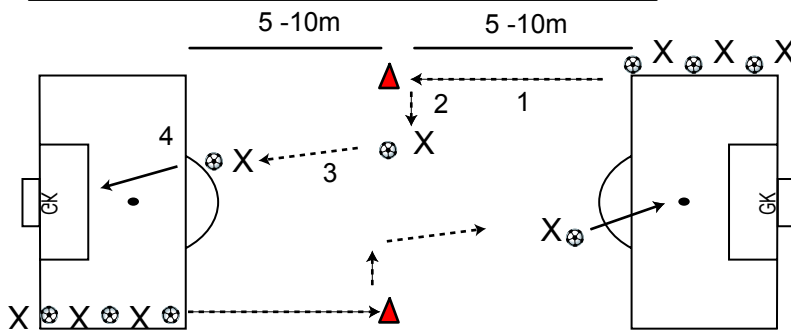

1. Dribble to cone.
2. Make a move on cone
3. Cut in on net
4. Set up a shot on net with your next touch and shoot.
5. Go to end of opposite line

Set up as many areas for drill as you need to keep players moving as much as possible.

## Fitness Drill: Reaction Sprints. (15 min)

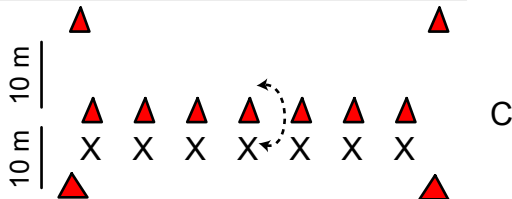

1. Players line up on one side of a row of cones.
2. Players jump sideways over cones.
3. On coach's (C) command "left" or "right" players sprint 10m to their right or left.

## Tactical Drill: Fake Defender and Shoot (15-30 min)

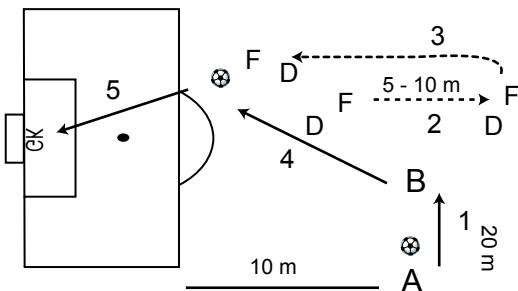

1. A passes to B who receives ball and turns with ball facing direction (4).
2. At the time A passes, F sprints back, being covered goalside by D. F and D look over their shoulder to have A and B in their view.
3. While the ball is still on it's way to B, F changes direction and sprints into space towards the goal, trying to lose D.
4. B now passes into the run of F.
5. F finishes with a shot.

## Scrimmage: 4+GK vs 4+GK on 2 Goals. (15-30 min)

- 4 v.4 play with GK on regular size goal.
1. Teams play ball into opposing half and then
2. they have to pass it back to a player in their own half who
3. then takes a direct shot on goal

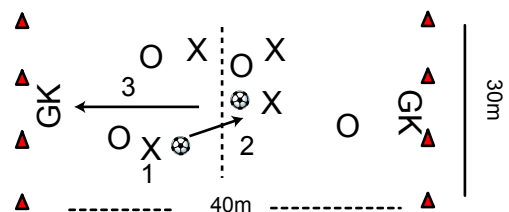

Players should be busy at all times. If drills keep players inactive, break team into smaller groups and run parallel drills.



# YOUTH SOCCER PRACTICE # 5

**Emphasis: Passing, Dribbling and Shooting**

**Time: 1.5-2 hrs including arrival/leaving**

## Warm-Up: Dribbling, Overlap Passing, Reaction (30 min.)

1. Dribble ball randomly around field using the inside and outside of either foot.
2. Runners stretch (hold 20 seconds each side, 3 reps/side)

3. groups of 3:

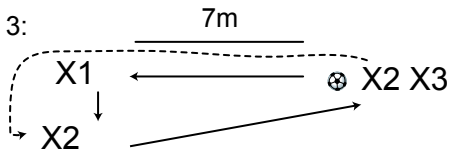

- X2 passes ball to X1 who touches it to the right
- X2 runs around X1 and passes ball with one touch to X3
- X3 passes to X1, X2 runs to his/her starting spot
- repeat 10 times and change roles

4. Quad stretch (hold 20 seconds each side, 3 reps/side)
5. In partners. One player dribbles ball, changing direction. Partner shadows him/her. Change roles.
6. Hamstring stretch. (hold 20 seconds each side, 3 reps/side)
7. Ball is one step distance between partners. On a command, both players try to pull ball back with sole of foot.
8. Heel stretch (hold 20 seconds each side, 3 reps/side)

## Technical Skill: Overlap Run with 2 vs 1 Plus Scoring. (15min)

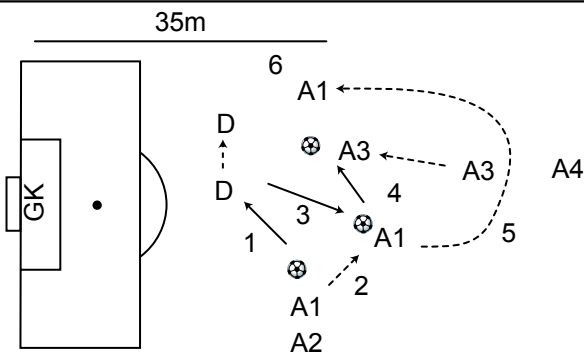

1. A1 passes to D and
2. times run towards A3
3. D one touch passes back into A1 run
4. A1 passes into run of A3 and
5. overlaps A3
6. A1 and A3 play 2v1 vs D ending with shot on net.

This drill may take some time to get right due to the precise timing of passes & runs required.

## Fitness Drill: Reaction Dribble and Sprint. (15 min)

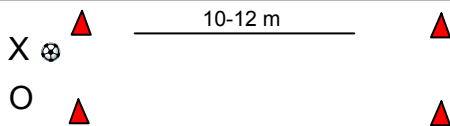

1. X has ball and decides when to start dribble across opposite endline.
2. O waits until X starts and then sprints trying to beat X to the endline
3. Change roles every 5 turns

## Tactical Drill: 3v3 Penetration, Passing, Shooting. (15-30)

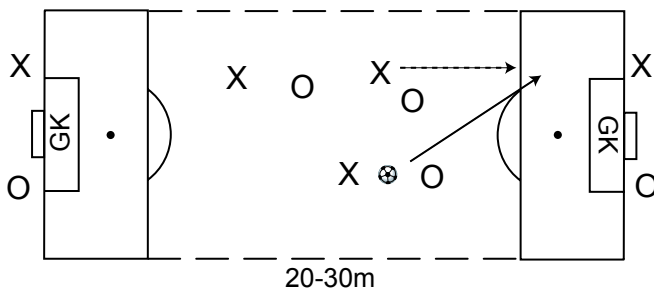

1. 2 teams of 3 play between penalty boxes.
2. each team can score on either goal
3. teams score by releasing their own player into the penalty box with a pass.
4. Once in penalty box, player cannot be attacked and must finish with shot on net.
5. A player from the team that has taken a shot waiting by the post now takes a ball and dribbles into center area where play restarts.

## Scrimmage: 4vs 4 on 4 Goals with GK (15-30 min)

Two teams of 4 play in a 30m x 30m field with 4 regular size goals. The third team provides 4 goalkeepers. Teams can score into opposite goals, i.e. X plays north/south and O plays east/west. Play 5 minute games and rotate each team through GK positions.

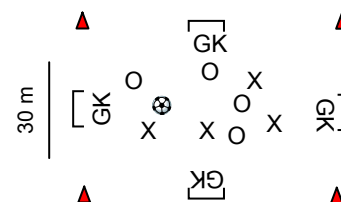

Players should be busy at all times. If drills keep players inactive, break team into smaller groups and run parallel drills.



# YOUTH SOCCER PRACTICE # 6

**Emphasis: Flank Attack, Shooting and Anticipation**

**Time: 1.5-2 hrs including arrival/leaving**

## Warm-Up: Anticipation, Dribble. (30 min.)

1. Each player with a ball. On the spot, do push/pull move, then do it while dribbling across field and back.
2. Runners stretch (hold 20 seconds each side, 3 reps/side)
3. Groups of five in 20x20 m grids. Each player gets a number from 1-5. Players must pass in numerical sequence. Emphasize moving to be ready to accept ball, and moving into space after passing. Everyone needs to read plays and know when his/her turn is coming up.
4. Quad stretch (hold 20 seconds each side, 3 reps/side)
5. Place 8 (3m wide) goals randomly across 1/2 field. Divide team into two groups and play 2 minute games. Team in possession scores a point by passing through any goal to a team-mate. Cannot score in same goal twice in a row.
6. Hamstring stretch.(hold 20 seconds each side, 3 reps/side)
7. Player with partner. Player with ball attacks and tries to execute a move to beat partner. Change roles
8. Heel stretch (hold 20 seconds each side, 3 reps/side)

## Technical Skill: Pass and Shoot.(15min)

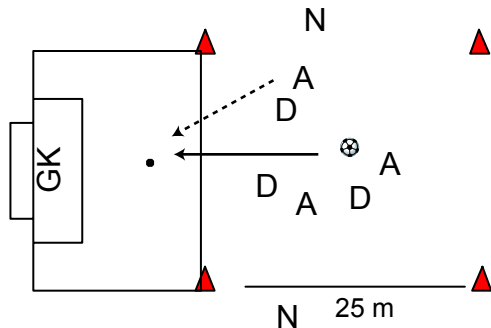

1. Play 3v3 in grid using Neutral players (N) as support player.
  2. A must play ball into area with a pass to a team-mate running into area.
  3. Once in area, A must shoot on 1st or 2nd touch.
  4. Defenders cannot follow into area.
  5. After goal or change of possession in grid, defenders try to score.
- Depending on number of players, set up two fields, or rotate players in groups of 3. Rotate neutral players as well.

## FitnessDrill: Sprint, 1 vs 1, and Shoot. (15 min)

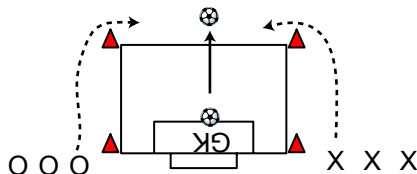

1. GK serves ball past top of the penalty box .
2. X and O react to ball and sprint around cones trying to win ball. They play 1v1 to score a goal.
3. After shot players return to end of opposite line
4. GK varies serve (low pass, bouncing, etc.)

## Tactical Drill: Flank Attack #1. (15-30 min)

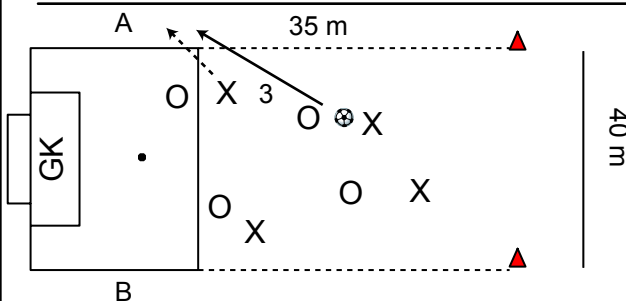

1. 4v4 in 40x35m grid. Two outside areas A and B
  2. X attacks goal and O defends.
  3. X must pass ball to team-mate into area A or B before they can score.
  4. Defenders (O) cannot enter area A or B.
  5. Once X has possession in area A or B they can cross ball into area for X to score.
  6. If defenders win ball, they fast break attack across opposite goal line.
- Make up teams of four and rotate.

## Scrimmage: 6 vs 4 + GK on 3 Goals. (15-30 min)

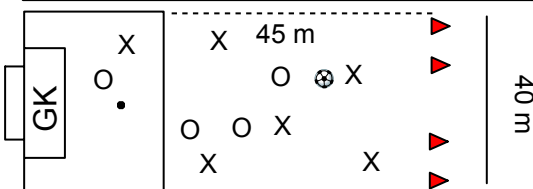

1. 6 X v. 4 O plus GK play on a regular size goal.
  2. After a goal by X or after winning ball, Os break to score on either of two (3 m wide) goals placed at the opposite sides of the field.
- Divide teams up and rotate through roles.

Players should be busy at all times. If drills keep players inactive, break team into smaller groups and run parallel drills.



# YOUTH SOCCER PRACTICE # 7

**Emphasis: Defending, Agility and Speed**

**Time: 1.5-2 hrs including arrival/leaving**

## Warm-Up: Agility Dribble. (30 min.)

1. Each player dribble a ball across field tapping it diagonally forward with outside/inside of same foot. Alternate feet.
2. Runners stretch (hold 20 seconds each side, 3 reps/side)
3. Dribbling the ball.

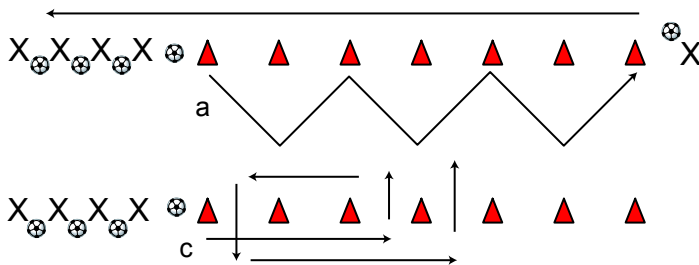

- a. Both lines dribble diagonally across from cone to cone and back on outside of the cones.
  - b. Quad stretch
  - c. Both lines dribble ball along the outside of 3 cones, drag it sideways across 3rd cone, drag it backwards 2 cones, and drag it across sideways. Repeat to last cone and then dribble back along outside of cones.
  - d. Insert ham string and heel stretches.
- Dragging: moving ball with sole of foot.

## Technical Skill: Defending 2 Goals. (15min)

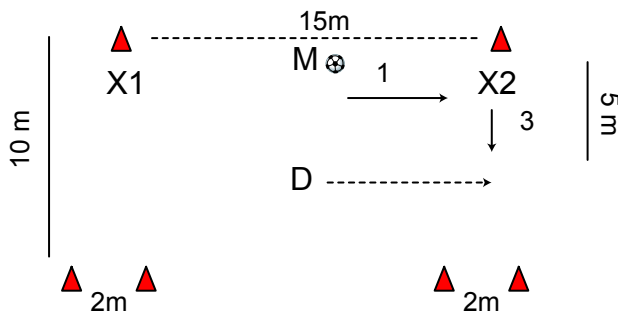

1. M starts with ball and passes to either X1 or X2 waiting at cones.
2. D hustles across to block shots on goals.
3. X1 or X2 either shoot on small goals or, if goal blocked by D, pass back to M who quickly decides whether to pass to X1 or X2.

Stress communication to get many clear shots. Rotate players through positions.

## Fitness Drill: Pass-Turn-Sprint-Pass (15 min)

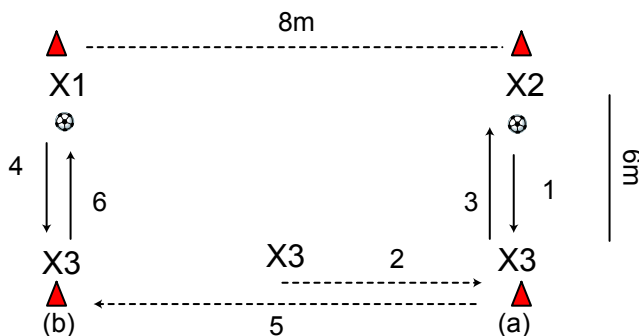

1. X2 passes ball towards cone (a) across.
2. X3 sprints toward cone (a)
3. X3 one touch passes ball back to X2 and turns to face cone (b)
4. X1 passes ball towards cone (b) across as soon as X3 has turned.
5. X3 sprints towards cone (b)
6. X3 one touches ball back to X1

Keep doing this for 60 seconds and rotate players through positions. Emphasize timing of passes and runs to cones.

## Tactical Drill: Defending 1 v 1. (20 min)

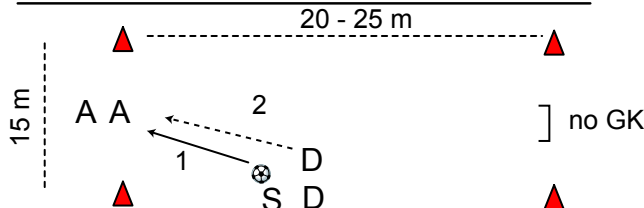

1. Server (S) passes ball to attacker (A).
2. Defender (D) sprints to close down attacker.
3. A and D play 1v1 on goal.

Coach defenders to stay goalside, delay attackers, keep proper distance, time tackle.

Alternate attackers and defenders.

## Scrimmage: 4 v 2; no Goals. (30 min)

1. 4 attackers v 2 defenders
2. Attackers must dribble across defenders endline (a) to score
3. Defenders get 1 point for winning ball, 2pts for clearing across attackers endline (b)

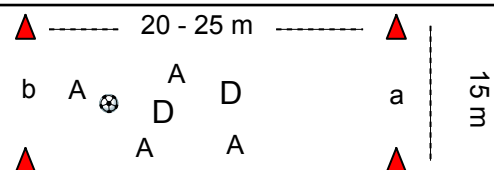

Players should be busy at all times. If drills keep players inactive, break team into smaller groups and run parallel drills.



# YOUTH SOCCER PRACTICE # 8

**Emphasis: Moves, Passing and Transition Play**

**Time: 1.5-2 hrs including arrival/leaving**

## Warm-Up: Moves #1. (30 min.)

1. With a partner (3-5 m apart) and a ball, run around 1/2 field twice passing ball diagonally forward to each other.
2. Runners stretch (hold 20 seconds each side, 3 reps/side)
3. Side drag/push move . Drag ball with sole of foot across body, then push in opposite direction with outside of foot.
4. Hamstring stretch.
5. Repeat side drag/push move with cones. After pushing ball w. outside foot, player now accelerates forward past cone.
6. Quad stretch (hold 20 seconds each side, 3 reps/side)

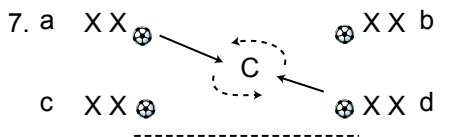

1. Coach (C) faces player from line a/d or b/c who now dribble at coach and make a move to get by low pressure defending coach.
2. Coach keeps rotating to face different players and diagonally opposite players start dribbling at coach.
3. Ask players to try various 1v1 moves to get by coach.

8. Heel stretch 25 m

## Technical Skill: 4 vs 2 Passing (15 min)

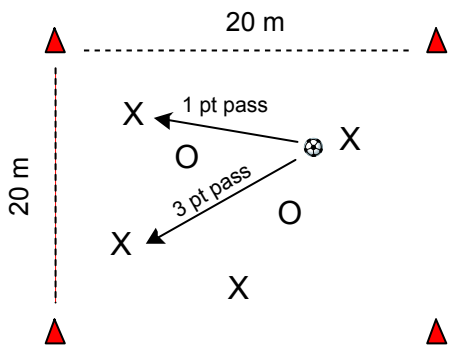

1. 4 v 2 in 20m x 20m grid.
2. Group of 4 keeps possession and scores:  
1 point for completed pass  
3 points for completed pass between defenders.

Rotate defenders every 3 minutes.

Emphasize movement, passing into space, angles of support (triangles in particular) and communication.

Keep track of points for possession teams.

## Fitness Drill: Pass-Turn-Sprint-Pass (15 min)

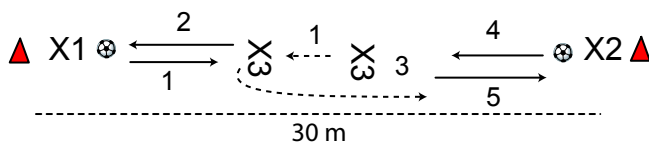

1. X1 passes to X3 who attacks ball.
  2. X3 one touches ball back to X1
  3. X3 immediately turns to face X2
  4. X2 passes to X3 as X3 is turning.
  5. X3 attacks ball, one touches to X2, etc.
- Rotate players every 60 seconds.

## Tactical Drill: Transition Play (15-30 min)

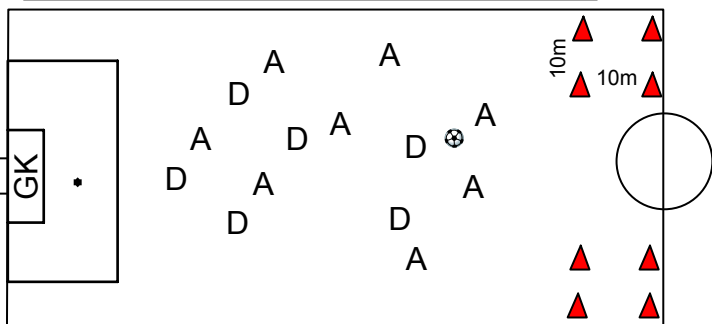

1. 8 v. 6+GK - 1/2 field.
2. Attackers (A) try to score on goal.
3. Defenders (D) upon winning ball must play it out into one of squares at the center line to score a point, 2 points if they pass it to another defender in the square

## Scrimmage: 5+GK vs 5+GK on 2 Goals

1/2 field scrimmage 5 v 5 on full size goals.  
With enough players rotate teams every 3 minutes.  
Emphasize running and passing into space,  
1v1 near goals followed by shots.

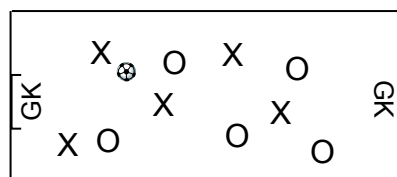

Players should be busy at all times. If drills keep players inactive, break team into smaller groups and run parallel drills.



# YOUTH SOCCER PRACTICE # 9

**Emphasis: Moves, Shooting and Flank Attack**

**Time: 1.5-2 hrs including arrival/leaving**

## Warm-Up: Moves #2. (30 min.)

1. Dribble ball around 1/2 field twice dribbling back and forth over side, center, and goal lines.
2. Runners stretch (hold 20 seconds each side, 3 reps/side)
3. Each player with ball. Stand beside ball and hop with both feet sideways over ball and back. 3 sets of 20.
4. Quad stretch (hold 20 seconds each side, 3 reps/side)
5. Each player with ball. Execute push/pull move (for pictures, click on moves on web page). Step on ball with sole of foot; pull back with sole; push to side with outside of same foot. Do stationary and while dribbling.
6. Hamstring stretch (hold 20 seconds each side, 3 reps/side).
7. Twist-off move around cones
  1. Dribble to cone.
  2. twist 3/4 turn at cone and dribble to next cone. Repeat
  3. pass to next player
8. Heel stretch (hold 20 seconds each side, 3 reps/side)

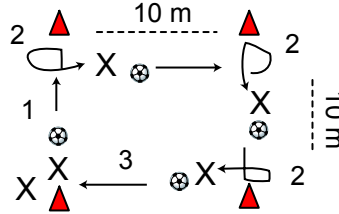

## Technical Skill: Dribble and Shoot #3. (15min)

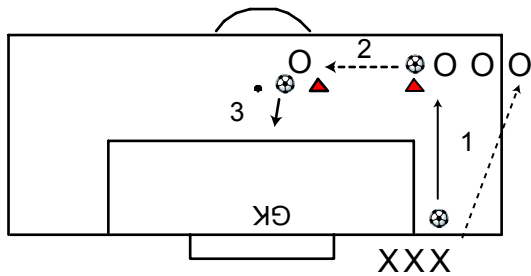

1. X passes to O. X follows pass and sprints to end of line O.
2. O receives pass, dribbles it past cone.
3. After second cone, player cuts to net and shoots. After shot player sprints around back of net to end of line O.

## Fitness Drill: Jump and Shoot. (15 min)

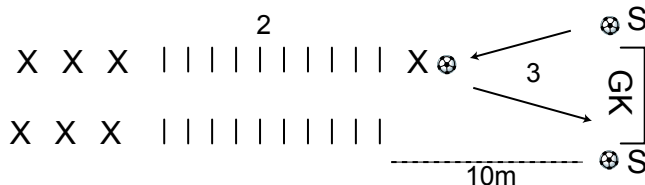

1. 10m from net, put 10 flat cones or rolled towels ~ 50 cm apart. Players from both rows:
2. run single step over obstacle.
3. After last obstacle, server (S) passes ball for shot on net. Alternate servers.
4. Repeat with side step, double leg hop forward, 3 hops forward/2 backward.

## Tactical Drill: Flank Attack #2. (15-30 min)

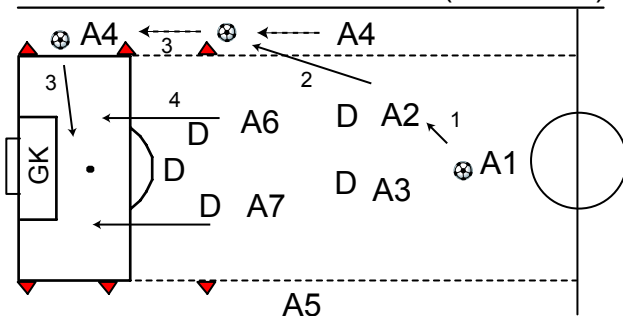

1. A1 starts with ball and plays it to A2 or A3
2. A2/A3 receive ball and turn for a pass into run of A4/A5.
3. A4/A5 receive ball in space and dribble outside cones close to goal line and cross ball into penalty box.
4. Strikers A6/A7 time run into box to get shot or header on net.
5. Defenders (D) are active at all times.

## Scrimmage: 6+GK vs 6+GK on 2 Goals 1/2 Field. (15-30 min)

1. Play across 1/2 field 6 v 6 on full size goals.
2. Every player of attacking team must be in opponent's half before they can score.
3. When attacking team loses ball, every player must run to mark their player goalside.
4. Emphasize communication to cover attackers

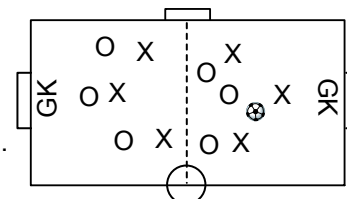

Players should be busy at all times. If drills keep players inactive, break team into smaller groups and run parallel drills.



# YOUTH SOCCER PRACTICE # 10

**Emphasis: Moves, Passing and Reaction**

**Time: 1.5-2 hrs including arrival/leaving**

## Warm-Up: Moves, Reaction (30 min.)

1. Groups of 3 run and pass ball across field 4 times (crossover runs, weaves - let them create passing patterns)
2. Runners stretch (hold 20 seconds each side, 3 reps/side)
3. Each player tap ball between feet while bouncing, drag ball 1/4 turn, repeat tapping, turning.
4. Shadow dribble:

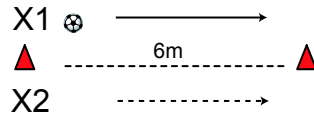

X1 dribbles ball between cones and changes direction often using several change of direction moves.  
X2 shadows X1 and tries not to be faked by X1's moves.  
Change role every 60 seconds

5. Hamstring stretch.(hold 20 seconds each side, 3 reps/side)
6. In pairs, execute scissors move vs. passive defender.
7. Heel stretch (hold 20 seconds each side, 3 reps/side)

## Technical Skill: 3 v 6 defending. (15min)

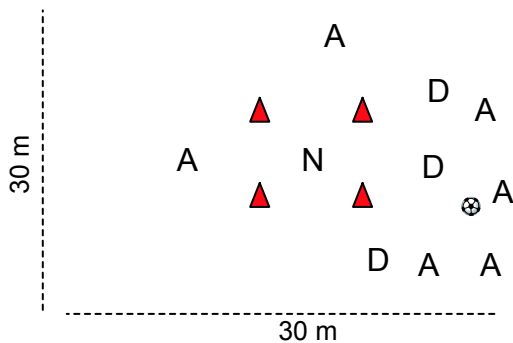

1. 6 attackers v 3 defenders in 30x30m grid.
2. One neutral (N) inside 5x5m grid.
3. Attackers get points for passing to neutral player in grid.
4. Defenders get point for getting control of ball.
5. When defenders get control, play restarts with attackers.
6. Rotate players through positions every 3 minutes.

## Fitness Drill: 2 vs 2 + N Fast Break. (15 min)

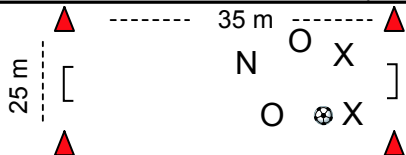

1. 2 v 2 + N on two small goals (2 m wide).
2. Neutral player plays with team in possession creating 3 v 2.
3. 3 minute games
4. Rotate every player through neutral position

## Tactical Drill: Pass and Follow. (15-30 min)

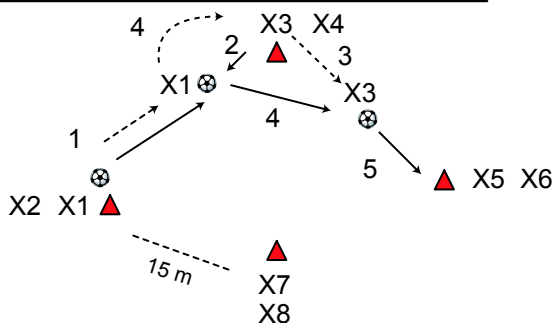

1. X1 passes ball to X3 and follows pass.
2. X3 one touch passes back to X1
3. X3 starts running towards X5
4. X1 passes into run of X3 and then X1 runs behind X4.
5. X3 passes to X5 (same as step 1) and the play continues until timing of passes and runs works smoothly.

You may have to try this before practice to understand how drill works.

## Scrimmage: 3 vs 3 + N on 4 Goals with GK. (15-30 min.)

1. 3 v.3 + N playing on opposite goals w. GK. (X plays east/west; O plays north/south)
2. 3 minute games, rotate players through GK & N positions.
3. Neutral player plays with team in possession

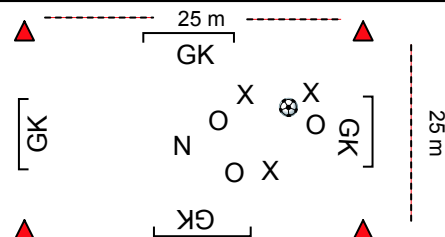

Players should be busy at all times. If drills keep players inactive, break team into smaller groups and run parallel drills.

# Youth Foundation

## Warm-Up Drills



## Warm - Up # 1: Dribbling & Receiving the Ball

1. Each player dribbles a ball around field in various sizes of the figure 8 using the same foot .
2. Runners stretch (hold 20 seconds each side, 3 reps/side)
3. In pairs, 10m apart, each pair with a ball. Player throws ball to partner's head and calls "catch" or "head". Partner does opposite of command, heads ball when call is "catch" and vice versa. Alternate.
4. Quad stretch (hold 20 seconds each side, 3 reps/side)
5. In pairs, 15m apart, each pair with a ball. Partner passes ball and calls either "man on" or "turn". "man on" requires one touch pass back , "turn" requires controlling ball, turning, dribble two steps turn again and pass back to partner, calling out either command.
6. Hamstring stretch.(hold 20 seconds each side, 3 reps/side)
7. Heel stretch (hold 20 seconds each side, 3 reps/side)

### Coaching Points/Progression

#### 1. Dribbling:

Start players with a "number 8" large enough to keep control of the ball while moving. Then increase dribbling speed and make the circles smaller. Encourage switching between inside and outside of foot when dribbling.

#### 2. Passing:

On the one touch pass back, the passer needs to call out command to partner right away. That may be challenging - in that case only have a command after the "turn" move. Ensure that the players call out the command in a timely manner giving the receiver enough time to react. As the drill gets easier to execute, reduce the time to react to the command.

### Coach's Notes



## Warm - Up # 2: Change of Direction Move

1. Each player dribbles a ball around perimeter of field twice .
2. Runners stretch (hold 20 seconds each side, 3 reps/side)
3. While dribbling slowly, execute scissors move (sweep right foot across front of ball and plant, take ball away with outside of left foot in opposite direction) against an imaginary defender. Alternate feet.
4. Quad stretch (hold 20 seconds each side, 3 reps/side)
5. In pairs, execute scissors move vs. passive partner. Alternate.
6. Hamstring stretch.(hold 20 seconds each side, 3 reps/side)
7. In pairs, execute scissors move vs. active defender.
8. Heel stretch (hold 20 seconds each side, 3 reps/side)

### Coaching Points/Progression

1. In the first move (step 3) you can place cones on the field and ask players to move from cone to cone.
2. Encourage dribbling with head up as much as possible.
3. Match players as partners based on skill, or, based on positions (i.e. forwards with defenders)
4. The key to a change of direction move is to slow down the dribble before the move, then change the direction executing the move, and finally to accelerate into the new direction.
5. An upper body fake in the opposite direction of the final direction can be added.

### Coach's Notes



## Warm - Up # 3: Dribbling, Moves

1. Form lines of 8 players and jog around 1/2 field. Last player weaves through line to front, etc.
2. Runners stretch (hold 20 seconds each side, 3 reps/side)
3. Tap ball 3-4 times between feet, then drag 1/4 turn to right with sole of foot. Repeat
4. Quad stretch (hold 20 seconds each side, 3 reps/side)
5. Dribble ball across field pushing it forward with laces, stopping with sole of foot, pushing forward, etc.
6. Hamstring stretch. (hold 20 seconds each side, 3 reps/side)
7. Repeat exercise 1 above, except each player has a ball and last player must dribble-weave to front.
8. Heel stretch (hold 20 seconds each side, 3 reps/side)

### Coaching Points/Progression

1. Ensure that players jog slow enough for the last player to weave through the line within a reasonable distance (say 20 - 25 m). The weaving player should not have to sprint all out, they should be between a jog and a sprint. Keep the distance between joggers just large enough for the weaving player to get through.
2. If players are comfortable tapping and dragging with one foot, ask to alternate feet. It is important to keep tight control of the ball.
3. In step (5), it is important to push the ball forward keeping it close to foot. A quick short step or two should be enough to reach it with sole of foot for the stop. Slow players down if they lose control of the ball or reach too far with their leg/foot to stop it.
4. For the dribble/weave in step (7) ask the players to keep their head up so they can maintain proper space to the player in front of them. Keeping the ball tight to feet is critical to avoid balls and/or players colliding.

### Coach's Notes



## Warm - Up # 4: Dribbling, Receiving the Ball, Reaction

1. Spread cones around field (2 per player) and ask each player to dribble towards a cone, change direction at cone.
2. Runners stretch (hold 20 seconds each side, 3 reps/side)
3. groups of 4:  

X1 ⊗	→	O1	↻
X2 ⊗	→	O2	

X1/X2 tosses ball to O1/O2 who plays it back to X1/X2 with one touch.  
O1 and O2 change place, X1 now tosses to O2, X2 to O1.  
After 2 minutes alternate and have O's throwing to X's.
4. Quad stretch (hold 20 seconds each side, 3 reps/side)
5. 25mx25 grid, each player dribble a ball. On coach's command, players exchange balls.
6. Hamstring stretch.(hold 20 seconds each side, 3 reps/side)
7. Repeat exercise 5 above, except that 2 players don't have a ball to start.
8. Heel stretch (hold 20 seconds each side, 3 reps/side)

### Coaching Points/Progression

1. Use a variety of moves from the web site and other drills in step (1). Encourage each player to think about their favourite (and hopefully best) move.
2. It is important that the drill in step (3) runs smoothly. This is accomplished by the players receiving the ball knowing which way they shuttle across, i.e. who is in front.  
The throws must be timed to reach the receivers at the same time, they must be accurate and to the feet. The one touch back ideally goes straight back into the hands of the throwers. Once the movements are smoothly synchronized, you can ask players to pick up speed by throwing sooner and shuttling faster.
3. In step (5) make sure players dribble with ball close to feet and with heads up so they are ready to get a ball on command by having identified who they want the ball from.
4. In step (7) the challenge for the players with the ball is to get a new ball before the players without the ball "capture" one. It shouldn't always be the same players without a ball.

### Coach's Notes



## Warm - Up # 5: Dribbling, Overlap Passing, Reaction

1. Dribble ball randomly around field using the inside and outside of either foot.
2. Runners stretch (hold 20 seconds each side, 3 reps/side)
3. groups of 3:

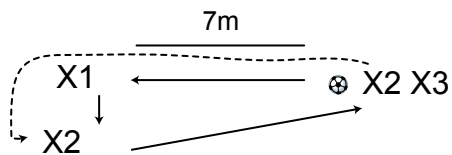

X2 passes ball to X1 who touches it to the right  
X2 runs around X1 and passes ball with one touch to X3  
X3 passes to X1, X2 runs to his/her starting spot  
repeat 10 times and change roles (X1)

4. Quad stretch (hold 20 seconds each side, 3 reps/side)
5. In partners. One player dribbles ball, changing direction. Partner shadows him/her. Change roles.
6. Hamstring stretch. (hold 20 seconds each side, 3 reps/side)
7. Ball is one step distance between partners. On a command, both players try to pull ball back with sole of foot.
8. Heel stretch (hold 20 seconds each side, 3 reps/side)

### Coaching Points/Progression

1. Overlap Passing (step 3)
  - a. X2 must weight pass to X1 so that X1 can easily touch it to the side. The touch (lay-off) pass must be controlled to be within 2 m of X1. X2 must sprint after passing such that ideally X2 arrives at the ball from X1 while the ball is still moving. Pass from X2 to X3 must be accurate and soft enough for X3 to one touch it forward.
  - b. Increase distance between X2 and X1 as needed for the speed of your players.
2. In step (7) make sure that players don't kick at the ball or tackle. The goal is to have the first who gets their foot (sole) on the ball wins and pulls it back.

### Coach's Notes



## Warm - Up # 6: Anticipation, Dribble

1. Each player with a ball. On the spot, do push/pull move, then do it while dribbling across field and back.
2. Runners stretch (hold 20 seconds each side, 3 reps/side)
3. Groups of five in 20x20 m grids. Each player gets a number from 1-5. Players must pass in numerical sequence. Emphasize moving to be ready to accept ball, and moving into space after passing. Everyone needs to read plays and know when his/her turn is coming up.
4. Quad stretch (hold 20 seconds each side, 3 reps/side)
5. Place 8 (3m wide) goals randomly across 1/2 field. Divide team into two groups and play 2 minute games. Team in possession scores a point by passing through any goal to a team-mate. Cannot score in same goal twice in a row.
6. Hamstring stretch.(hold 20 seconds each side, 3 reps/side)
7. Player with partner. Player with ball attacks and tries to execute a move to beat partner. Change roles
8. Heel stretch (hold 20 seconds each side, 3 reps/side)

### Coaching Points/Progression

1. In step (1) you can shorten the distance based on age, skill, and speed of your players.
2. In exercise (3) players need to learn everyone else's number. If they get lost initially and don't remember where to pass to next, then ask the player who should receive the ball next to ask for the pass by calling their own number. This is a great drill to teach communication.
3. For step (5) adjust the size of the field to your team's abilities. It is most effective to pass the ball from within 2-4 m from the goal to a player who has moved in position on the other side. Players who just wait will be easily covered. Therefore ask for lots of running into spaces and ask for the final pass through a goal to a player who is just running to the other side, not simply waiting there.
4. In step (7) emphasize body motion fakes for player with ball. Train defender to keep "eye on ball" and time tackle when the ball has been moved furthest from the foot of the attacking player. Make sure players tackle the ball, not the ankles or legs.

### Coach's Notes



## Warm - Up # 7: Agility Dribble

1. Each player dribble a ball across field tapping it diagonally forward with outside/inside of same foot. Alternate feet.
2. Runners stretch (hold 20 seconds each side, 3 reps/side)

3. Dribbling the ball.

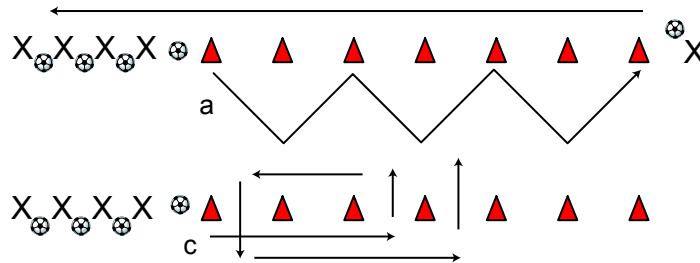

- a. Both lines dribble diagonally across from cone to cone and back on outside of the cones.
- b. Quad stretch
- c. Both lines dribble ball along the outside of 3 cones, drag it sideways across 3rd cone, drag it backwards 2 cones, and drag it across sideways. Repeat to last cone and then dribble back along outside of cones.
- d. Insert ham string and heel stretches.

Dragging: moving ball with sole of foot.

### Coaching Points/Progression

1. Depending on time available, age and speed of players, shorten the distance in step (1).
2. In 3(a) players are encouraged to dribble with head up to avoid collision with players from opposite line. Ask them to keep ball close to feet and dribble as close to cones as possible before changing direction. The change of direction can be any move, although the simplest to start with (for right footed players) is to cut with inside foot when turning left and with outside foot when turning right. Remind them to dribble quickly to cone, slow down at cone, make the move and then accelerate out of the turn. Space distance between two rows of cones to suit your team.
3. In 3(c) space the time between dribblers remembering that they will be coming back. You may want to wait sending the second player until the first one reaches the last cone.
4. You may want to reduce the number of players to three per line if you have enough cones.

### Coach's Notes



## Warm - Up # 8: Moves # 1

1. With a partner (3-5 m apart) and a ball, run around 1/2 field twice passing ball diagonally forward to each other.
2. Runners stretch (hold 20 seconds each side, 3 reps/side)
3. Side drag/push move . Drag ball with sole of foot across body, then push in opposite direction with outside of foot.
4. Hamstring stretch.
5. Repeat side drag/push move with cones. After pushing ball w. outside foot, player now accelerates forward past cone.
6. Quad stretch (hold 20 seconds each side, 3 reps/side)

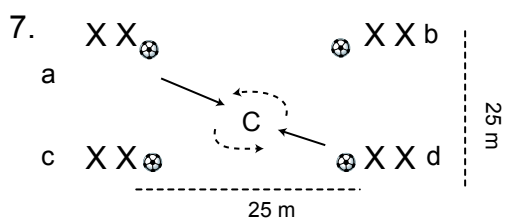

1. Coach (C) faces player from line a/d or b/c who now dribble at coach and make a move to get by low pressure defending coach.
2. Coach keeps rotating to face different players and diagonally opposite players start dribbling at coach.
3. Ask players to try various 1v1 moves to get by coach.

8. Heel stretch

### Coaching Points/Progression

1. In step (1), do the second lap in reverse direction so players need to use other foot. The player on the inside should be encouraged to pass with outside of foot.
2. In step (7), you can replace the coach with a defender. It is important to be a passive defender allowing players to beat them with a good move. Try to only intercept balls which the attacker loses control of.
3. Attackers need to approach coach fast, slow down just ahead of (C), make their move, and accelerate away.
4. The reason for two diagonal lines attacking at the same time is to force the players to keep their head up to avoid collision with the opposite line after the move is made. They also need to communicate verbally or through body language to make sure they don't make their move to the same side of (C) and thus colliding.

### Coach's Notes



## Warm - Up # 9: Moves # 2

1. Dribble ball around 1/2 field twice dribbling back and forth over side, center, and goal lines.
2. Runners stretch (hold 20 seconds each side, 3 reps/side)
3. Each player with ball. Stand beside ball and hop with both feet sideways over ball and back. 3 sets of 20.
4. Quad stretch (hold 20 seconds each side, 3 reps/side)
5. Each player with ball. Execute push/pull move (for pictures, click on moves on web page). Step on ball with sole of foot; pull back with sole; push to side with outside of same foot. Do stationary and while dribbling.
6. Hamstring stretch (hold 20 seconds each side, 3 reps/side).
7. Twist-off move around cones
  1. Dribble to cone.
  2. twist 3/4turn at cone and dribble to next cone. Repeat
  3. pass to next player
8. Heel stretch (hold 20 seconds each side, 3 reps/side)

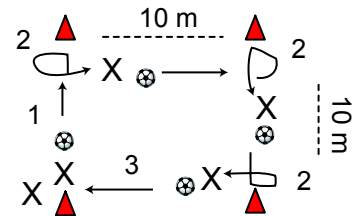

### Coaching Points/Progression

1. In step (1), do the second lap in reverse direction so players need to use other foot. Make the laps smaller (like the perimeter of the penalty box) for younger teams. If there are no painted lines to dribble across back and forth, ask players to imagine the lines. The important part is that they change direction and not simply dribble in a straight line.
2. In step (3) ask players to single hop over ball. If they can't allow them to "land" first and then hop back across in a second move.
3. In the twist-off (7) drill, it is important for players to dribble tightly to the cone and make the 3/4 spin in front of the cone, not dribble around the cone. They need to keep the ball close to the foot and with several touches with the inside of the foot execute the turn. After the turn they accelerate to the next cone and finish with a good pass to the player waiting at the first cone.
4. To avoid waiting, have 2 players with a ball starting to dribble and two players waiting. Adjust distance between cones to suit your team.

### Coach's Notes



## Warm - Up # 10: Moves, Reaction

1. Groups of 3 run and pass ball across field 4 times (crossover runs, weaves - let them create passing patterns)
2. Runners stretch (hold 20 seconds each side, 3 reps/side)
3. Each player tap ball between feet while bouncing, drag ball 1/4 turn, repeat tapping, turning.
4. Shadow dribble:

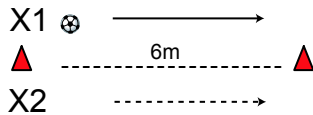

X1 dribbles ball between cones and changes direction often using several change of direction moves.

X2 shadows X1 and tries not to be faked by X1's moves. Change role every 60 seconds

5. Hamstring stretch.(hold 20 seconds each side, 3 reps/side)
6. In pairs, execute scissors move vs. passive defender.
7. Heel stretch (hold 20 seconds each side, 3 reps/side)

### Coaching Points/Progression

1. In step (1), allow creativity of patterns. One example to get you started:  
Have the player in the middle start with the ball and pass into run of player on his right. Middle player then overlaps player on the right while player on right passes across into run of player on the left. Player who just passed runs into center and receives ball from player on left.  
Repeat pattern.
2. In step (3), players bounce on the ball of their feet (dancing) while tapping ball back and forth.
3. In the shadow dribble (4), the player with the ball needs to accelerate away with the ball, then frequently change direction. Suggestions: a) step on ball and turn; b) cut back with inside foot c) pull back with sole of foot and pivot around. X2 needs to react to body fakes. As with all proper defending, X2 needs to keep "yes on ball".
4. In step (6), progress to active defending if the moves are executed successfully.

### Coach's Notes

# Youth Foundation

## Technical Skills



## Technical Skill # 1: Change of Direction Dribble and Shoot

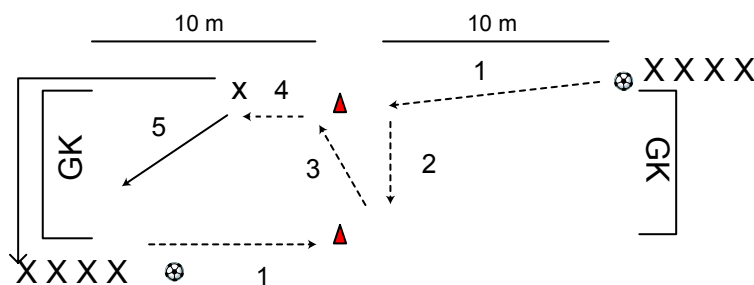

1. X dribbles ball to cone
2. X changes direction and dribbles to opposite cone
3. X changes direction and dribbles diagonally across, wide of the net.
4. X sets up shot with one last touch
5. X shoots and runs to end of opposite line

Both lines do drill at same time avoiding collision at center by looking up.

### Coaching Points/Progression

1. Ask players to dribble as close to cones as possible without ball touching cone.
2. Get right up to first cone and make a sharp cut with inside foot (right footed dribble).
3. At the second cone, cut the ball inside with outside of foot.
4. Back at the first cone (step 3-4) cut back with inside foot.
5. The final (4) touch prior to shot should have the ball angled towards the direction of the shot (goal) and set up the ball such that the player can strike the ball with the next step.
6. Aim the shot for the far post.
7. When players are executing the dribble well, progress as follows:
  - a. dribble with both feet and alternating inside/outside of foot.
  - b. speed up dribbling speed.
  - c. dribble with head up looking at other players and goal while controlling ball close.
8. Make sure players look up at their target before taking the shot.

### Coach's Notes



## Technical Skill # 2: Change of Direction Cut Backs

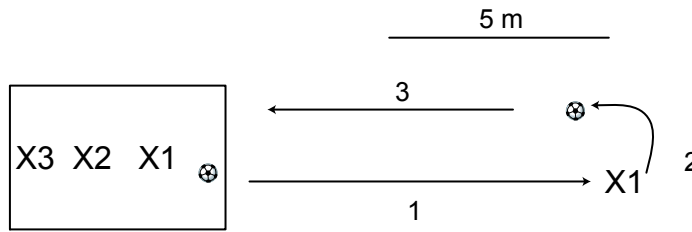

Groups of 3

1. X1 passes ball 3-5 m out and sprints after it
2. X1 cuts ball back with inside of foot
3. X1 passes ball to x2 and sprints to end of line
4. X2 repeats

Ask players to execute quick turn with outside of foot and flicking straight back with sole of foot in step 2.

### Coaching Points/Progression

1. Ask your players for a perfectly weighted pass so that they will get to it after pass within the prescribed distance. Place a cone at 5 m if necessary.
2. Players need to pivot around when they cut the ball back with the inside foot. If they pass too hard and sprint too fast they may have difficulty executing the turn - slow them down to get the turn right, then speed them up again.
3. The pass back to the player waiting must be perfectly weighted as well, such that the next player can pass it forward with the first touch. If the pass is too hard, the receiver may lose control. If the pass is weighted properly and one touch pass out is too hard, allow two touches initially.

### Coach's Notes



## Technical Skill # 3: Dribble & Shoot # 1

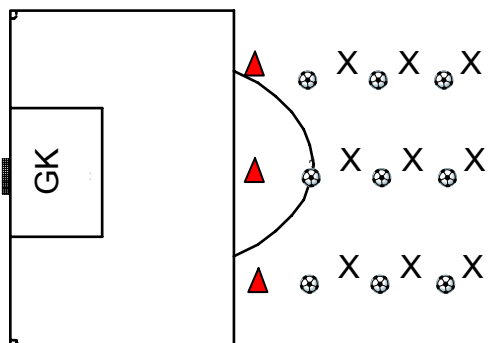

1. Dribble to cone.
2. Make a move on cone into the penalty box.
3. Finish with a shot on net with your first touch inside penalty box.

It is important to make sure that the last touch into the penalty box is diagonal and away from shooting foot to set up the shot.

If groups are too large and players stand around, set up a second/third goal with cones.

### Coaching Points/Progression

1. Depending on skill of players you may restrict the drill to two lines to avoid confusion.
2. Make sure that the shot is taken before a player from the next line starts. That should give the goalkeeper enough time to reset. It is important to give the keeper the time to reset, but at the same time encourage the keeper to get up as quickly as possible after a save or goal.
3. The goalkeeper must be focused on the next shot and not worry about the last one he may have missed.
4. The final touch into the penalty box should be diagonal to set up maximum body rotation which in turn maximizes power for the shot.
5. Players must look at the target (far post ideally) before striking the ball.
6. The last touch before the shot should be towards the target.

### Coach's Notes



## Technical Skill # 4: Dribble & Shoot # 2

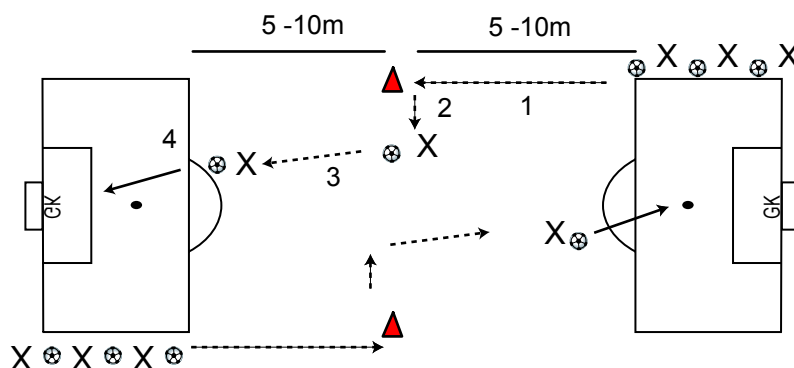

1. Dribble to cone.
2. Make a move on cone.
3. Cut in on net
4. Set up a shot on net with your next touch and shoot.
5. Go to end of opposite line

Set up as many areas for drill as you need to keep players moving as much as possible.

### Coaching Points/Progression

1. Ask players to dribble as fast as possible while keeping close control of the ball. Advanced players can use either foot or alternate feet to dribble.
2. The best move at the first cone is a cut with inside foot, however, advanced players can use any move as long as it does not slow them down
3. Moves at the cone require slowing down, changing direction, acceleration.
4. The final touch before the shot should be diagonal in the direction of net.
5. Players need to lift their head, pick the target, and aim the shot (far post recommended).
6. Emphasize accuracy of shot over power initially.
7. Time the shots so that the goalkeepers have time to recover.
8. Players should never have to stop after they start the first dribble.
9. If you have a lot of left footed players, set up a second drill allowing players to end up with a left footed shot.

### Coach's Notes



## Technical Skill # 5: Overlap Run with 2 v 1 plus Shooting

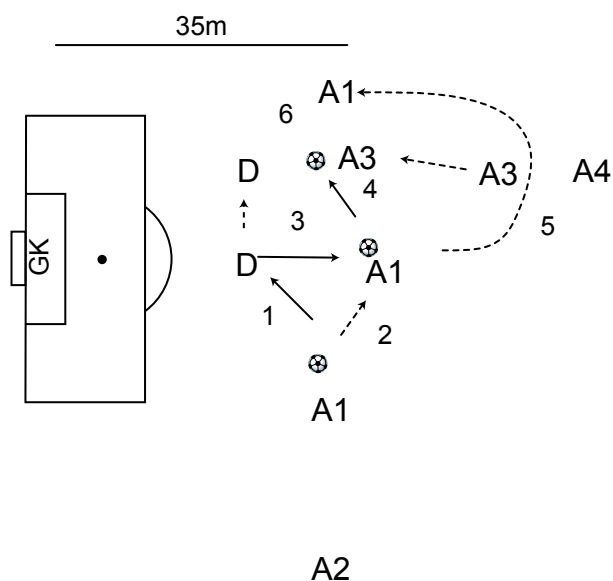

1. A1 passes to D and
2. times run towards A3
3. D one touch passes back into A1 run
4. A1 passes into run of A3 and
5. overlaps A3
6. A1 and A3 play 2v1 vs D ending with shot on net.

A2 and A4 wait to restart as soon as previous players are done.

This drill may take some time to get right due to the precise timing of passes & runs required.

### Coaching Points/Progression

1. This is an excellent drill to practice timing of passes and runs.
2. The key is to ensure that the pass and the runner arrive at the same place at the same time.  
For example:
  - a. pass from D back to A1 must be such that A1 doesn't have to wait for ball or have to chase it. If either happens it will throw off the rest of the sequence.
  - b. A3 must time the run (likely delay) until they are sure A1 has control and is able to pass it.
3. Players need to look up and be aware of their team mates positions and movements. This is an excellent drill to emphasize that looking at one's feet and the ball is not enough.
4. Adjust the distances and the speed of passing to allow success.
5. If your team struggles understanding the runs initially, have them walk through the sequence to be more comfortable.

### Coach's Notes



## Technical Skill # 6: Pass and Shoot

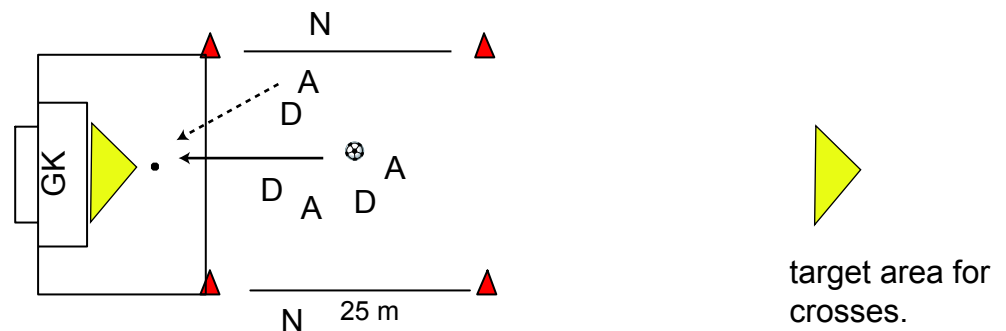

1. Play 3v3 in grid using Neutral players (N) as support player.
  2. A must play ball into area with a pass to a team-mate running into area.
  3. Once in area, A must shoot on 1st or 2nd touch.
  4. Defenders cannot follow into area.
  5. After goal or change of possession in grid, defenders try to score.
- Depending on number of players, set up two fields, or rotate players in groups of 3. Rotate neutral players as well.

### Coaching Points/Progression

1. Players, and especially younger or less experienced teams, will try to play through the middle to set up a quick shot on goal. They will tend to forget the neutral players.
2. Ask them to use the neutral players and show them how that "stretches" the defense.
3. Neutral players can cross the ball into box for a "free" header or shot. Therefore, when a neutral player has the ball at least one attacker must anticipate the cross and make a run to the "danger" areas (triangle from top of 6 yd box goal post high to penalty spot)
4. Neutral players can also play ball back into field of play outside penalty box and player receiving can play through middle or pass it along to opposite neutral player.
5. Neutral players must play it back to the team that passed them the ball.
6. If there are lots of changes of possession then likely passes are inaccurate, runs are poorly timed, or too many 1v1 dribbles. Stop the drill and correct these.
7. Stress lots of communication.

### Coach's Notes



## Technical Skill # 7: Defending 2 Goals

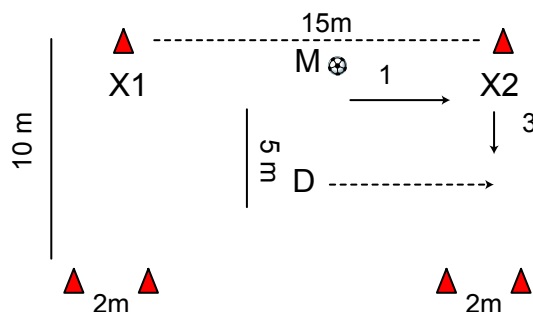

1. M starts with ball and passes to either X1 or X2 waiting at cones.
2. D hustles across to block shots on goal
3. X1 or X2 either shoot on small goals or, if goal blocked by D, pass back to M who quickly decides whether to pass to X1 or X2.

Stress communication to get many clear shots. Rotate players through positions.

### Coaching Points/Progression

1. Defender (D) needs to react quickly to direction of play to block shot by X1/X2.
2. Defenders can slide tackle a shot to stop it from going past.
3. Quick and accurate passing between X's and M is critical to get defender out of position and generate a clear shot.
4. M should be a midfielder player, X's can be midfielders or forwards.
5. Within each group, rotate players through each position.
6. Have more than one ball per group to keep the play going after a shot. Have volunteers behind the little goals if possible.
7. A progression is to remove the midfielder and have X's pass to each other. This will speed up the drill and put more pressure on defenders.

This is an excellent drill to train defender reaction, shot blocking, slide tackling; as well as change of direction and quick passing for attackers.

### Coach's Notes



## Technical Skill # 8: 4 v 2 Passing

1. 4 v 2 in 20m x 20m grid.

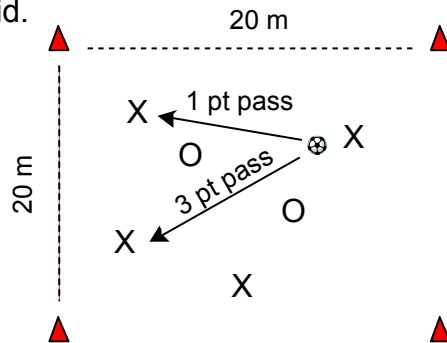

2. Group of 4 keeps possession and scores:

1 point for completed pass

3 points for completed pass between defenders.

Rotate defenders every 3 minutes.

Emphasize movement, passing into space, angles of support (triangles in particular) and communication.

Keep track of points for possession teams.

### Coaching Points/Progression

1. X's need to constantly move to set up an opportunity for the pass between defenders. This is best accomplished by a couple of short and "square" passes while the fourth attacker "sneaks" behind the defenders and is now open for the through pass.
2. This is where thinking about and setting up triangles is of value.
3. Defenders need to decide who challenges player with the ball. The second, or covering, defender needs to decide which passing lane to cut off.

This is an excellent drill to train attackers to play the "deadly" splitting the defense pass.

You can make the drill easier for attackers by adding a fifth X, or more difficult by adding a third defender.

### Coach's Notes





## Technical Skill # 10: 3 v 6 Defending

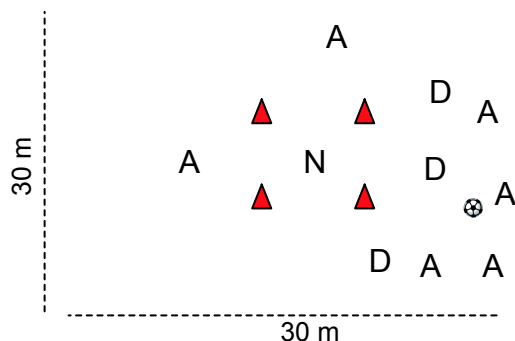

1. 6 attackers v 3 defenders in 30x30m grid.
2. One neutral (N) inside 5x5m grid.
3. Attackers get points for passing to neutral player in grid
4. Defenders get point for getting control of ball.
5. When defenders get control, play restarts with attackers.
6. Rotate players through positions every 3 minutes.

### Coaching Points/Progression

1. As shown in the diagram, all defenders should be between the ball and the neutral player (N) to prevent a successful pass. This will force the attackers to have players come to the ball for passes to work the ball to the other sides of the grid N is in. Attackers cannot pass ball high through the grid.
  2. Encourage attackers to have players available on either side of the grid to create two outlet passing options.
  3. Defenders need to react very quickly to the passes by attackers so they can move and block the shot from the side the attackers are now on.
  4. Defenders will learn to block shots and should be encouraged to slide to block shots.
  5. Neutral player must move with play to be in position to receive an easy pass.
- Adjust the size of the grid the neutral player is in to either increase success or provide a to the attackers if they score points too often.

### Coach's Notes

# Youth Foundation

## Fitness Drills



## Fitness Drill # 1: Run - Sprint - Shoot

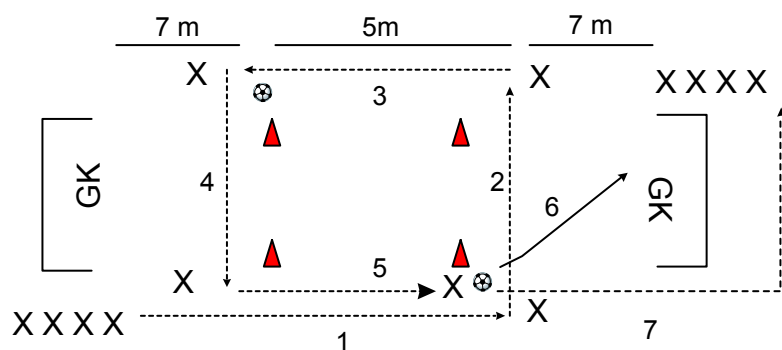

1. X half sprints to second cone
2. X sidesteps to cone across
3. X runs backwards to 4th cone
4. X sidesteps to cone 1
5. X sprints to ball
6. X shoots ball on target
7. X sprints to back of other line

Coach/helper replaces ball for next shot

Both lines do drill at same time, avoiding collisions.

### Coaching Points/Progression

1. Sidestep (2) means facing goal while shuttling across.
2. While running backwards players can look over their shoulder to keep straight.
3. Aim shot at far post and keep it low.
4. To keep the drill moving have a supply of balls at the shooting position and a person placing a new ball for the next player.
5. You can adjust the running and shooting distance to suit your team's abilities.
6. Instead of a shot, you can throw the ball for a header (GK can do this).
7. This drill also helps goalies, so make sure they play the angle properly.
8. Time the running such that the goalkeeper has time to reset before the next shot.

### Coach's Notes



## Fitness Drill # 2: Cooper Test

All players are asked to for a 12 minute run around field.

Record # of laps for each player.

Depending on age and competitiveness of team, variations more suitable can be chosen. The important thing is to have players work at an elevated heart rate for at least 12 minutes.

### Coaching Points/Progression

1. Ask players to bring running shoes if possible, particularly if ground is hard.
2. Make sure they run very close to the side lines of the field so that everyone's distance is the same for each lap.
3. Be aware of the weather. If it is a very hot and/or humid day, monitor your players as they run. This is a test to gauge fitness, not to complete 12 minutes. You may need to split it into 2 x 6 minutes with a water break in between. The point is not to do this test in any more strenuous conditions than what the team will be subjected to in a game.
4. Record the number of laps for everyone and repeat the test in the middle and at the end of the season to see if fitness levels are improving.

### Coach's Notes



## Fitness Drill # 3: Change of Direction Sprints

Groups of 4

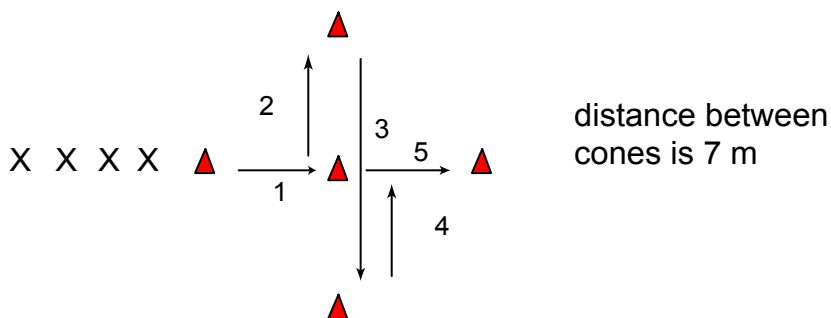

1. Player sprints from 1st to 2nd cone and makes sharp turn to left.
2. Sprints to 3rd cone, sharp reverse turn.
3. Sprints to 4th cone, sharp reverse turn
4. Sprints back to 3rd cone, sharp turn right
5. Sprints to 5th cone, turns and jogs back

### Coaching Points/Progression

1. The sharp turns are done by pushing off the outside foot to the new direction, i.e. at the first turn to the left players need to push off with their right foot.
2. The second and third turns are 180 degree turns and players should not run a loop, they must pivot and quickly push off the foot closest to the cone.
3. Proper footwear to avoid slipping is important.
4. You may add some competition by having groups race against each other.

### Coach's Notes



## Fitness Drill # 4: Reaction Sprints

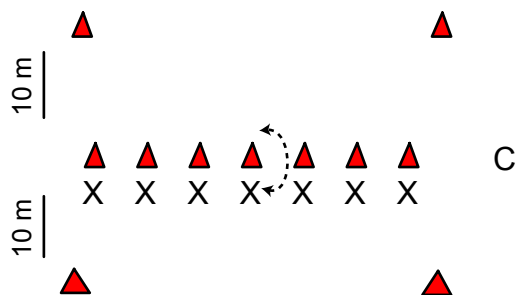

1. Players line up on one side of a row of cones.
2. Players jump sideways over cones.
3. On coach's (C) command "left" or "right" players sprint 10m to their right or left.

### Coaching Points/Progression

1. Sideways jumps are with both feet in the air and getting over top of cones.
2. Use the command between 1 and 6 jumps so that players do more sprinting than jumping.
3. Players will learn to focus on proper jumping technique while also focusing on the coach anticipating the command.
4. Make sure you define which direction is left and which is right so that everyone knows. A suggestion is to use the coach's right hand as "right" direction.
5. Players need to push off into the direction of the sprint as soon as they hear the command.

### Coach's Notes



## Fitness Drill # 5: Reaction Dribble and Sprint

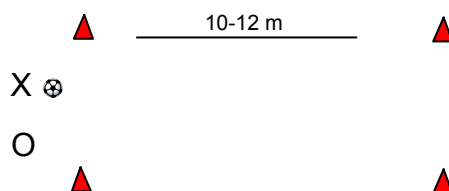

- 1.X has ball and decides when to start dribble across opposite endline.
- 2.O waits until X starts and then sprints trying to beat X to the endline
- 3.Change roles every 5 turns

### Coaching Points/Progression

1. The beginning of the dribble is when X first touches the ball and O can't run until that happens.
2. Allow X to trick O once with a fake start to throw O off balance. O will have to reset and that is the time when X starts the actual speed dribble. O will now have to catch up.
3. During the dribble X must keep ball close to foot. They are not allowed to kick the ball and sprint after it. 5-8 touches should be the goal.
4. The coaching point for O is to focus on the ball, not the body movements of X. The reaction is to ball movement, not player movement. This is a key concept for defenders: "eyes on ball".

### Coach's Notes



## Fitness Drill # 6: Sprint, 1 v 1 and Shoot

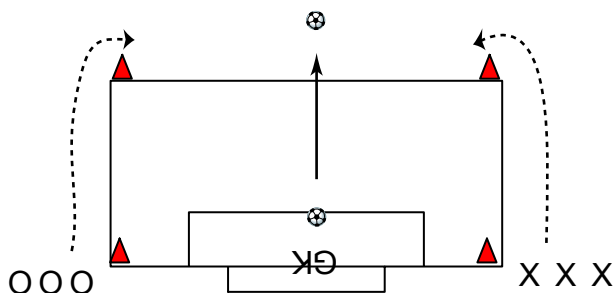

1. GK serves ball past top of the penalty box .
2. X and O react to ball and sprint around cones trying to win ball. They play 1v1 to score a goal.
3. After shot players return to end of opposite line
4. GK varies serve (low pass, bouncing, etc.)

### Coaching Points/Progression

1. GK needs to have supply of balls to keep drill moving.
2. GK can vary his service out to be further out or to one side providing players with different challenges. GK can serve ball on ground, throw it or loft it high to make control difficult.
3. Players must sprint to ball. If one of the two thinks he cannot get to ball first, they should make a goal side run and assume the defender's role immediately. This requires judgment and decision making.
4. Once they are 1 v 1, both players can score. Emphasize use of 1 v 1 moves.
5. If players are deadlocked, stop drill (no more than 15 seconds per pair).

### Coach's Notes



## Fitness Drill # 7: Pass - Turn - Sprint -Pass

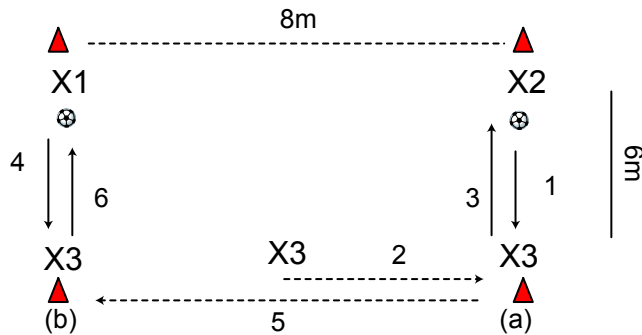

1. X2 passes ball towards cone (a) across.
2. X3 sprints toward cone (a)
3. X3 one touch passes ball back to X2 and turns to face cone (b)
4. X1 passes ball towards cone (b) across as soon as X3 has turned.
5. X3 sprints towards cone (b)
6. X3 one touches ball back to X1

Keep doing this for 60 seconds and rotate players through positions. Emphasize timing of passes and runs to cones.

### Coaching Points/Progression

1. It is critical that the runner (X3) and the ball played by X1/X2 arrive at the cone at the same time.
2. The stationary players X1/X2 must lead the runner with the pass to make sure that X3 has to sprint "all out" to meet the ball at the cone.
3. X1/X2 must play a soft pass so that the runner has a decent chance to play a one touch back without wasting time and touches to control the pass.
4. X1/X2 will learn a lot about timing of passes into space and weight of pass into a run.
5. To challenge the runner more, widen the distance between cones (a) and (b).

### Coach's Notes



## Fitness Drill # 8: Pass - Turn - Sprint -Pass 2

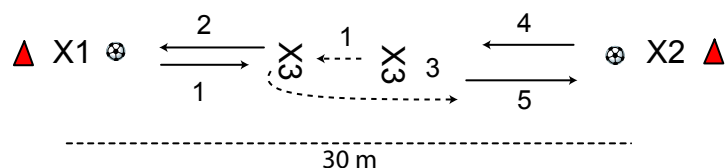

1. X1 passes to X3 who attacks ball.
  2. X3 one touches ball back to X1
  3. X3 immediately turns to face X2
  4. X2 passes to X3 as X3 is turning.
  5. X3 attacks ball, one touches to X2, etc.
- Rotate players every 60 seconds.

### Coaching Points/Progression

1. The first pass by X1 needs to be a "soft pass" so that X3 in the middle has at least 8 m to sprint.
2. The weight of the pass to X3 must allow X3 to be able to play a controlled one touch pass back.
3. X2 must time their pass to leave their foot after X 3 has turned and again force X3 to sprint to collect the ball within 5-7 m of X2.
4. Vary the distances based on age, skill, and fitness level of your plauers.
5. Players will tire at about 45 seconds so be encouraging and push them to finish strong. Call out such as "only 15 seconds - finish strong" and repeat with 5 seconds left.
6. Even though players tire, emphasize accuracy of passes back from the middle player.

### Coach's Notes



## Fitness Drill # 9: Jump and Shoot

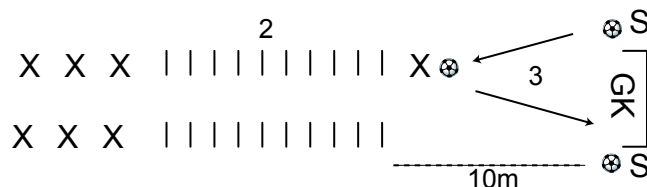

1. 10m from net, put 10 flat cones or rolled towels ~ 50 cm apart. Players from both rows:
2. run single step over obstacle.
3. After last hop server (S) passes ball to runner for a shot on net. Alternate servers.
4. Repeat with side step, double leg hop forward,  
3 hops forward/2 backward.

### Coaching Points/Progression

1. Ideally, you would have low hurdles for this drill, or a speed ladder.
2. You can be creative for the type of hops and their sequence you want.
3. The servers should be players. You could ask the players who finish the shot to be the server and the server to sprint to the end of the line. Your choice depending on the flow.
4. It is important for the pass out to be timed after the last hop is complete so that the runner has time to set and approach the ball properly for a first touch shot.
5. The shot should be from ~ 7m out to start, but you may increase that distance.
6. GK should start 2m off the goal line, but you may increase the challenge and ask GK to come out and cut the angle, especially if you move the shot further away from the goal.
7. If you can, set up as many stations for this drill as equipment allows.

### Coach's Notes



## Fitness Drill # 10: 2 v 2 + N Fast Break

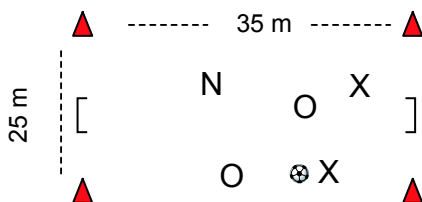

1. 2 v 2 + N on two small goals (2 m wide).
2. Neutral player plays with team in possession creating 3 v 2.
3. 3 minute games
4. Rotate every player through neutral position

### Coaching Points/Progression

1. It is important for neutral player to make runs so they are an easy target for a pass.
2. Encourage short and long passes into space.
3. Defenders need to challenge the player with the ball, while the second defender covers the other two players.
4. Allow 1v1 moves to set up a 3v1 play, but remind players that in a 3v2 situation fast runs and quick passing is more effective than 1v1 plays.
5. Once defenders get control of the ball they counter attack and the neutral player must be a quick thinker because they now have "new" team mates and are attacking the opposite goal.
6. This is excellent training for midfielders as neutrals (N) to become "two-way" players.
7. Adjust the size of the field to suit the ability of your team.  
Think about who you want to play together (FW vs MF?; D vs FW?; F+M vs D+M?)

### Coach's Notes

# Youth Foundation

## Tactical Drills



## Tactical Drill # 1: Flank Attack with Switching Play

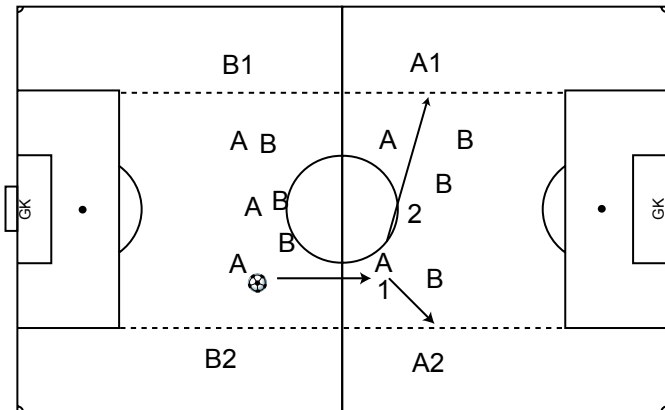

A1/A2 & B1/B2 stay in their lanes and cannot be challenged.

Teams must play into a wide lane (1) before they can score.

Encourage teams to switch play (2) to stretch the defense.

### Coaching Points/Progression

1. Line up your teams with players in positions they usually play.
2. When switching the play, ask to do the switch in two passes. You can adjust this based on the ability and strength (for long passes) of your team.
3. Progression options:
  - a. allow the wide players to leave their lanes after they pass the ball out.
  - b. allow all lane players to play out and only ask one player to run into the lane if they want the ball. This requires lots of communication.
  - c. allow players to be challenged in the lanes.

The critical success factor of this drill is to play the ball into the lanes fast and then generate a scoring chance quickly through a dribble and cross, or a direct diagonal cross. Players not in lanes must make the runs to receive passes and crosses.

### Coach's Notes



## Tactical Drill # 2: 1 v 1 Change of Direction

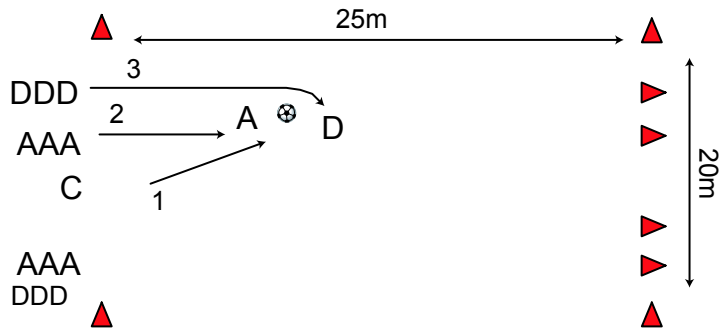

1. Coach (C) passes ball diagonal to either attacker A
2. A sprints to get control of ball.
3. Defender D sprints to beat A to ball or, to get goalside of A (shown).
4. A now plays 1v1 against D on either goal.
5. Either player can score.
6. A goal or coach's call ends 1v1. Players jog back around outside field to opposite line.
7. Coach restarts game on other side.

### Coaching Points/Progression

1. It is important that the attackers get to the ball first. If you have slow attackers, play the ball closer to the attacker to give them a chance to get control.
2. If the attackers are fast and break for goal before the defender has caught them, play a tougher ball (bouncing off ground, toss into air).
3. Once the attacker has control, they need to make a decision which goal to attack. Encourage them to make that decision as quickly as possible.
4. Attackers will tend to pick one goal to attack and then keep going for that goal. The reason for having two goals is to encourage the attacker to make a quick change of direction to get a clear path to the other goal.
5. Once the 1 v 1 is complete, make sure the two players leave the grid quickly so they don't interfere with the next pair.

### Coach's Notes



## Tactical Drill # 3: Fast Break Attack

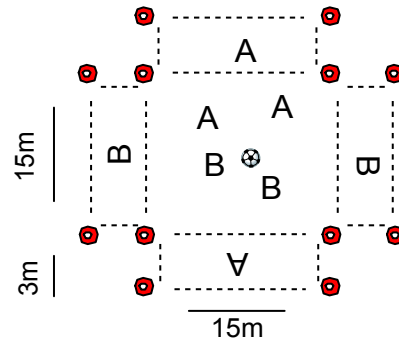

1. teams A/B play against each other inside 15m x 15m grid.
  2. each team has a player in opposing 3m deep end zones.
  3. players must pass into either end zone from within 2m, sprint to end zone, and stay as target player.
  4. End zone player breaks out fast to start his team playing into opposite end zone.
- 1 pt for each successful pass. Team w. 10 pts wins.

### Coaching Points/Progression

1. The players in the grid must pass to each other so that one of them gets a clear pass into the end zone from within 2 m. They need to make runs into space. An effective way to lose the defenders is to attack one goal and suddenly and quickly change direction and attack the opposite goal.
2. Players waiting in the end zones must move with the play so that they are facing the player passing to them. The pass to them must be soft enough so that they can control it easily.
3. Players in end zone must break out quickly with their first touch and look for a pass to their partner who hopefully has moved into open space.
4. Players initially may forget to follow their pass into the end zone. Stop and re-explain the drill.

### Coach's Notes



## Tactical Drill # 4: Fake Defender and Shoot

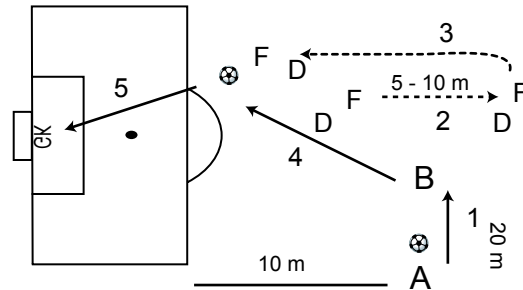

1. A passes to B who receives ball and turns with ball facing direction (4).
2. At the time A passes, F sprints back, being covered goalside by D. F and D look over their shoulder to have A and B in their view.
3. While the ball is still on it's way to B, F changes direction and sprints into space towards the goal, trying to lose D.
4. B now passes into the run of F.
5. F finishes with a shot.

Set up on both goals or as many goals as necessary to keep players engaged.

### Coaching Points/Progression

1. You need to decide (or let players decide) if the pass from A to B triggers the runs by F and D, or if the run by F triggers the run by D and the pass by A. The key is that F has enough time to sprint, change direction, and receive the pass from B in space.
2. SLOW down the drill until everyone understands how it is supposed to work.
3. Defenders tend to "cheat" by staying back wanting to cut off the pass to F. That is because they know the drill. You must ask them to stay within arm's length of the forward at all times.
4. Forwards need to be creative in faking out the defender to keep the defender moving while they have changed direction and sprint towards goal. A simple rapid body motion in the direction of the run usually does the trick.
5. Shot by F should be a first touch shot and therefore the pass from B must be well placed.
6. Use midfielders in position A/B, but rotate players through positions.

This drill make take some time to get right, be patient and consider running it at another practice.

### Coach's Notes



## Tactical Drill # 5: 3 v 3 Penetration Passing & Shooting

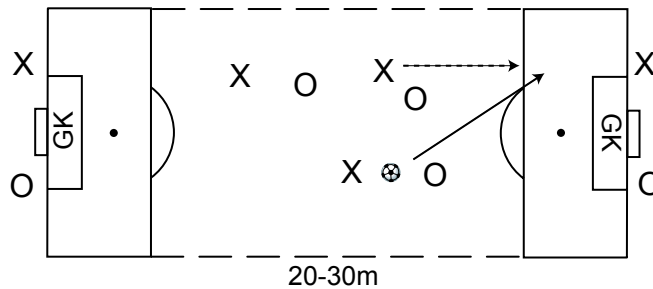

1. 2 teams of 3 play between penalty boxes.
2. each team can score on either goal
3. teams score by releasing their own player into the penalty box with a pass.
4. Once in penalty box, player cannot be attacked and must finish with shot on net.
5. A player from the team that has taken a shot waiting by the post now takes a ball and dribbles into center area where play restarts.

### Coaching Points/Progression

1. Once the ball is played into the penalty box, defending team cannot follow.
2. The player running into the penalty box takes a one-time shot if possible. Therefore the pass must be weighted and angled properly and should be on the ground. If a first touch is necessary to set up a second touch shot, then make sure the player plays a good first touch.
3. Encourage teams to change direction. For example if there is a lot of pressure and congestion near one penalty box making a good pass difficult by the team with the ball, then train the team in possession to reverse direction and attack the opposite goal. This could be as simple as one player breaking into the opposite direction and shouting "switch" to signal a pass. This pass could be directly into the box for a one time shot.
4. The players waiting at the posts ideally each have a ball and are ready to power dribble out of the box. They cannot be challenged until they leave the box. They must look to play a pass to a team mate quickly.

### Coach's Notes



## Tactical Drill # 6: Flank Attack # 1

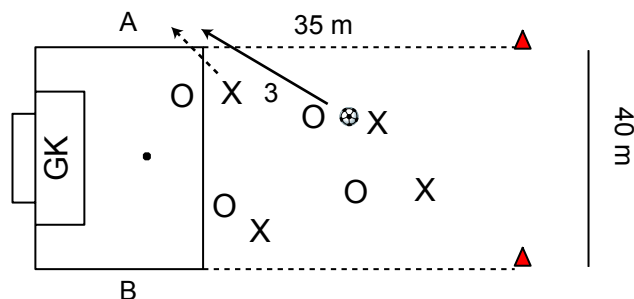

1. 4v4 in 40x35m grid. Two outside areas A and B
  2. X attacks goal and O defends.
  3. X must pass ball to team-mate into area A or B before they can score.
  4. Defenders (O) cannot enter area A or B.
  5. Once X has possession in area A or B they can cross ball into area for X to score.
  6. If defenders win ball, they fast break attack across opposite goal line.
- Make up teams of four and rotate.

### Coaching Points/Progression

1. The pass to players in the wide lanes should ideally be into their run. The wide players should never run into wide areas and stay there waiting for the ball.
2. X in wide area can cross ball (preferred) or play it back into the middle. The latter is less preferred because O has an extra player in that area.
3. X's must time their runs to target areas for crosses.
4. If attackers are having little success, add players to them, playing 5 v 4 or 6 v 4.
5. If attackers are successful, allow defenders into wide lanes to defend.
6. Defenders winning ball must break to opposite end line. This means attackers must immediately transition to defense and try to win ball back before defenders get to the line.

### Coach's Notes



## Tactical Drill # 7: Defending 1 v 1

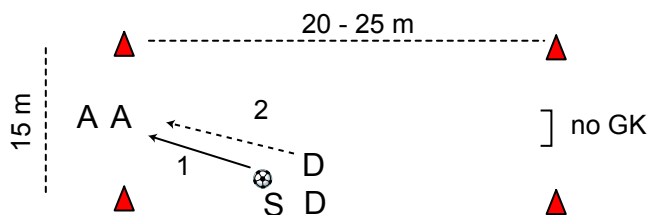

1. Server (S) passes ball to attacker (A).
2. Defender (D) sprints to close down attacker.
3. A and D play 1v1 on goal.

Coach defenders to stay goalside, delay attackers, keep proper distance, time tackle.  
Alternate attackers and defenders.

### Coaching Points/Progression

1. Server can be a coach or a midfield player (preferred).
2. Do not allow defenders to cheat by anticipating pass and closing down attacker too soon. They need to wait until the ball is passed and react to the ball leaving the server.
3. This is an excellent drill to train defending principles:
  - a. close down attackers as fast as possible - sprinting.
  - b. stop extended arm's length away from attacker, keep arm out if necessary to distract and block attacker.
  - c. angle the body with one foot leading to allow quick pivoting when attacker changes direction.
  - d. keep eye on the ball, not the body, and only tackle the ball when the attacker loses tight control. This usually occurs when they push the ball ahead to make a move.
  - e. defenders should try to angle their body between attacker and ball when they go for the tackle, leading with the shoulder.

### Coach's Notes



## Tactical Drill # 8: Transition Play

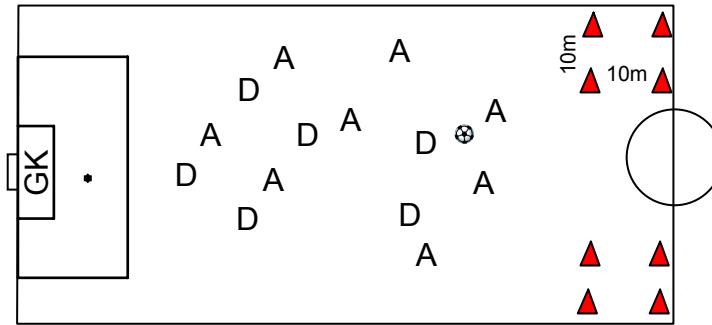

1. 8 v. 6+GK - 1/2 field.
2. Attackers (A) try to score on goal.
3. Defenders (D) upon winning ball must play it out into one of squares at the center line to score a point, 2 points if they pass it to another defender in the square

### Coaching Points/Progression

1. This is an excellent drill to train the functional units of your team according to your system of play. For example, if you play a zonal 4-4-2, set up attackers with two defenders, 4 midfielders, and two forwards. Your defenders would be 4 defenders and 2 midfielders.
2. Use your starting line up in the primary positions and substitutes to fill in the A's and D's.
3. The key point of this drill is for both teams to transition as fast as possible. As soon as defenders win possession, they must break out fast with as few passes as possible to reach the target squares. Likewise, the attackers upon gaining possession, must quickly attack the goal. It is critical to success to play fast so that the opponent does not have time to settle into position.
4. Attackers should play wide and switch side of attack to stretch the defense and then attack goal.
5. Have balls ready at the goal and outside the squares so that teams can restart quickly after a ball goes out of bounds. Throw-ins are permitted per usual rules, but there are no corner or goal kicks. GK restarts play with a throw to a breaking defender.

### Coach's Notes



## Tactical Drill # 9: Flank Attack # 2

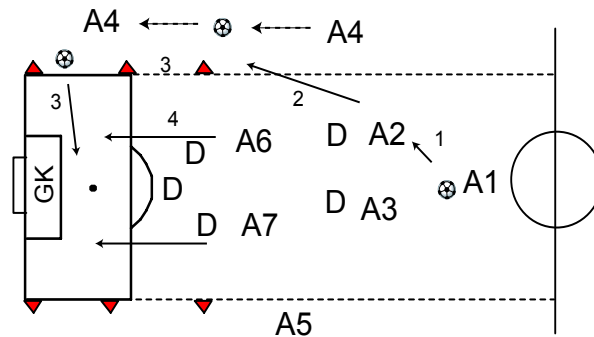

1. A1 starts with ball and plays it to A2 or A3
2. A2/A3 receive ball and turn for a pass into run of A4/A5.
3. A4/A5 receive ball in space and dribble outside cones close to goal line and cross ball into penalty box.
4. Strikers A6/A7 time run into box to get shot or header on net.
5. Defenders (D) are active at all times.

### Coaching Points/Progression

1. It is critical that the pass from A1 is accurate. A2 or A3 need to control the ball with their first touch in the direction of the the pass, which should be the second touch. At the same time they must shield the ball from the challenging defenders.
2. Initially, ask defenders to be passive, i.e. not to challenge until the passing is accurate.
3. A2 and A3 must decide before they receive the ball where the pass will go. Initially, ask them to pass to the near side lane, then allow them to choose the short or the long (switching) pass.
4. Initially, you may want A2/A3 to be stationary to receive the ball. Once successful, they should move to lose their defender and receive the ball into space. At this point, A1 will have two options to pass to and they need to choose the player with the best chance of receiving the ball in space.
5. A4 and A5 must delay their runs until they know that the ball is passed to them. Players need to communicate. Passes must be into space in front of A4/A5. Forwards must delay their run into the penalty box until the cross is coming in. Then they need to sprint to where the ball will be.

### Coach's Notes



## Tactical Drill # 10: Pass and Follow

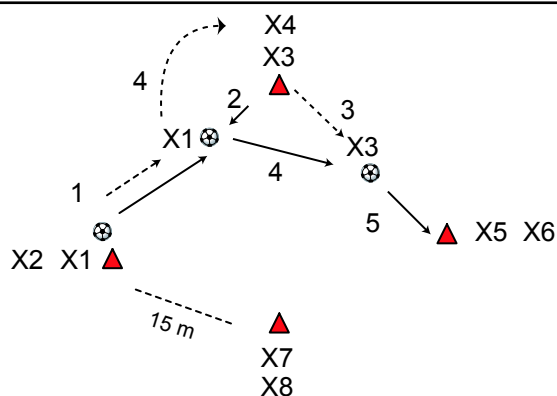

1. X1 passes ball to X3 and follows pass.
2. X3 one touch passes back to X1
3. X3 starts running towards X5
4. X1 passes into run of X3 and then X1 runs behind X4.
5. X3 passes to X5 (same as step 1) and the play continues until timing of passes and runs works smoothly.

You may have to try this before practice to understand how drill works.

### Coaching Points/Progression

1. Players wait for passes in front of cones.
2. This is a very difficult drill as it relates to timing of passes and runs. You may need to ask your players to walk through the sequences to understand the movements required.
3. The first pass must be accurate so that X3 can one touch return the ball into the run of the oncoming X1. As soon as X3 passes the ball back, they turn and face X5.
4. X3 should delay the run until they know that X1 has received the return pass, has control and passing diagonally across. The pass by X1 will be a challenge because it will either be with the outside of the right foot or with the left foot (tough for right footed players).
5. Once X3 has received the return pass, the play essentially restarts with a pass to X5 and the sequences repeat.
6. You may need to increase the distance between the cones to allow enough space for the pass to players at cones and the return pass.

Reverse direction of play once everyone is executing. Be patient.

### Coach's Notes

# Youth Foundation

## Scrimmage Focus



## Scrimmage # 1: 4 v 4 on two Goals

Choose 4v.4 small games and set up small fields.

Vary rules as to number of touches ,player position, moves.etc. before goal can be scored.

Or

Play full field scrimmage with a particular tactical objective.

### Coaching Points/Progression

1. If setting up small fields, adjust the size of the fields to force a lot of passing or 1v1's, i.e. make the fields reasonably small.
2. Use cones to make 2 m wide goals, no goalkeepers.
3. Consider making the small groups based on how they line up in your team. This can take the form of groups of defenders, midfielders, forwards, OR, put "vertical" groups together consisting of defender(s), midfielder(s) and forward(s). Use the small sided game to get players to get used to each other.
4. Be creative with special rules but make sure they are consistent with your style of play.
5. If you have little time before your first season game consider a full field game. If you don't have enough players to field two full teams recruit volunteers (parents, brothers, sister, friends) to make up the opposition. This also enhances the "fun" part of the game.

### Coach's Notes



## Scrimmage # 2: 3 v 3 on two Goals

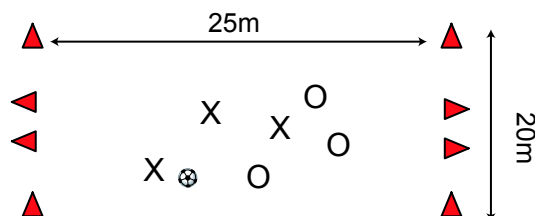

1. Divide team into small teams of 3 and set up a field for each 6 players.(18 players-3 fields)
2. Play 3 v 3 in tournament format, 2 min.games.
3. Emphasize 1 v 1 moves to set up a pass or shot on goal.
4. Goals must be scored from inside opponent's half

### Coaching Points/Progression

1. Make the goals approximately 2 m wide.
2. Adjust the size of the playing field to suit the age and skill level of your players.
3. If teams can't be split into groups of 3, use extra players on some teams and rotate them into the teams of 3.
4. You may want to put the teams together based on:
  - a. compatible skill levels
  - b. groups that play together as units in a game (defenders in a group, midfielders, etc.)
  - c. vertical play, i.e. one defender, midfielder, forward in each group.

### Coach's Notes



## Scrimmage # 2: 4 v 4 on 4 Goals

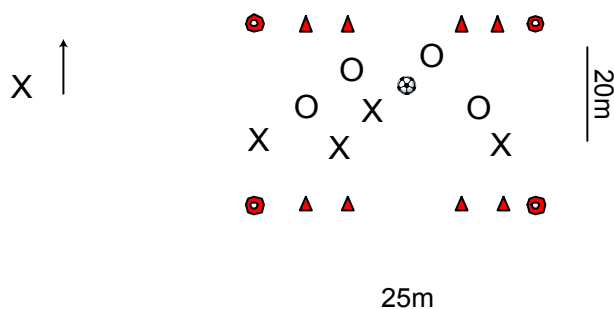

1. 4 v.4 play on four goals.
2. teams score by dribbling ball in either goal in opposing end. (goals are 2m wide).
3. team that scores restarts play by playing ball in from sideline.

### Coaching Points/Progression

1. The team without the ball and defending two goals often chooses to put a player in each goal to prevent the score against. While not encouraged, you can allow this. At the same time let your players know that this sets up a 4 v 2 in the field and should make it easy for the attacking team to isolate either goal attacking it with two players and no defenders. If players guard their nets this way, make the goals wider.
2. Ideally you want to have players challenge and cover properly with no one standing in goal.
3. If the defending team wins possession of the ball they need to break quickly across to catch the opponent off-balance and out of position. The better this works the lower the likelihood of players getting back to stand in the goals.
4. Switching the attack from one side to the other will become an effective way to generate scoring chances, just like in a real game.

### Coach's Notes



## Scrimmage # 4: 4 + GK v 4 + GK on 2 Goals

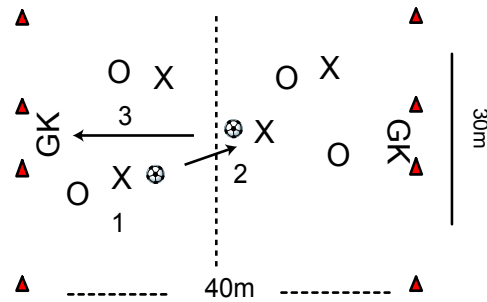

4 v.4 play with GK on regular size goal.

1. Teams play ball into opposing half and then
2. they have to pass it back to a player in their own half who
3. then takes a direct shot on goal

### Coaching Points/Progression

1. When a team has possession in its own half, at least two players need to break with fast runs into space into the other half. Defenders, of course, try to stay with them.
2. The player passing across must also move to be able to receive the ball back for a shot. They must lose their defender.
3. It may be necessary to move 3 or all 4 players into the attacking half before one player moves back into own half to receive the pass before the shot.
4. This is a good drill to encourage variation. Teams need to decide how many players to send across and how many to hold back for them to get a shot away.
5. If teams are struggling to get shots, then ask all defending players to move across the half keeping one open attacker back to at least get the opportunity of a shot without pressure.

The key point is to make the runs to get into space and to get free to take a shot.

### Coach's Notes



## Scrimmage # 5: 4 v 4 on 4 Goals with GK

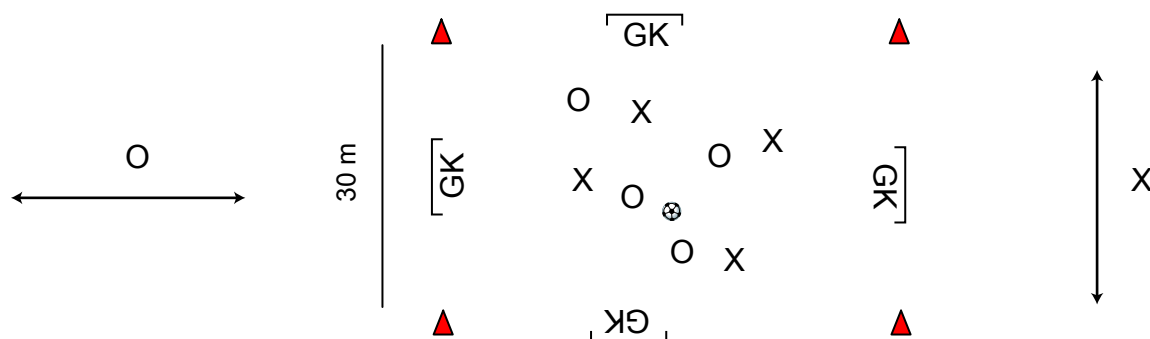

Two teams of 4 play in a 30m x 30m field with 4 regular size goals.

The third team provides 4 goalkeepers.

Teams can score into opposite goals, i.e. X plays north/south and O plays east/west.

Play 5 minute games and rotate each team through GK positions.

### Coaching Points/Progression

1. This drill is ideal to train switching direction of play.
2. In the diagram, O has the ball and is attacking the goal on the right. X need to decide if they want to keep a player behind the O with the ball (as shown) because O could reverse direction and score. If X keeps a player behind, then O's now have a 4 v 3 on the goal they are attacking. The best decision would be to have X pressuring O with ball from behind and once O is past the half to sprint and get in front of O.
3. If X wins the ball, the direction of play now changes as X's attack one of the other two goals. O's need to be aware that they are now defending two goals opposite in direction to the attack they just finished. They need to get into challenge and cover position.
4. Player need to communicate frequently and clearly, especially when defending to organize themselves.
5. After a ball goes out of bounds, a goal is scored, or GK makes save, GK restarts.

### Coach's Notes



## Scrimmage # 6: 6 v 4+GK on 3 Goals

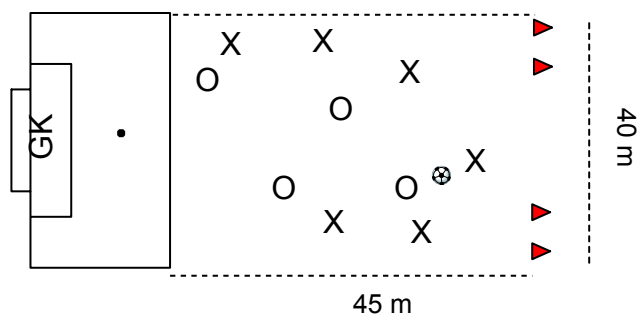

1. 6 X v. 4 O plus GK play on a regular size goal.

2. After a goal by X or after winning ball, Os break to score on either of two (3 m wide) goals placed at the opposite sides of the field.

Divide teams up and rotate through roles.

### Coaching Points/Progression

1. Arrange the two teams to fit your system of play, i.e. flat back four zonal defenders or, sweeper plus four defenders, etc. Attacking team can be 4 mids and two forwards, etc.
2. This is an excellent drill to train defenders how to deal with situations when they are outnumbered. Emphasize one defender challenging the player with the ball, while the others need to cover attackers goal side. Which attackers to leave open? The ones furthest away from scoring areas.
3. Once defenders win ball they need to break to wide goals. It is important to get them in the habit to transition to the outsides. Attackers now need to transition to defend and win the ball back.
4. Change size of field, number of players per team to suit your team's strengths and formation.

### Coach's Notes



## Scrimmage # 7: 4 v 2, no Goals

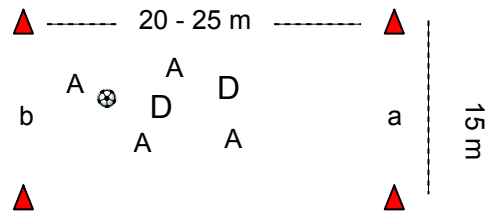

1. 4 attackers v 2 defenders
2. Attackers must dribble across defenders endline (a) to score
3. Defenders get 1 point for winning ball, 2pts for clearing across attackers endline (b)

### Coaching Points/Progression

1. It is important for four attackers to be in constant motion seeking open spaces to receive the ball.
2. Attackers must play a passing game, if they hang on to the ball and dribble they will allow defenders too much time to organize and win the ball.
3. The final pass by the attackers must be to a player within 1 - 2 m of goal line to dribble across unchallenged.
4. Defenders need to challenge player with ball, the second defender needs to cover other attackers closing down passing lanes. As soon as player with ball passes, the defender who was challenging needs to move into cover position because the previously covering defender should now be challenging.
5. add defenders if attackers are having too easy a time.

### Coach's Notes



## Scrimmage # 8: 5+GK v 5+GK on 2 Goals

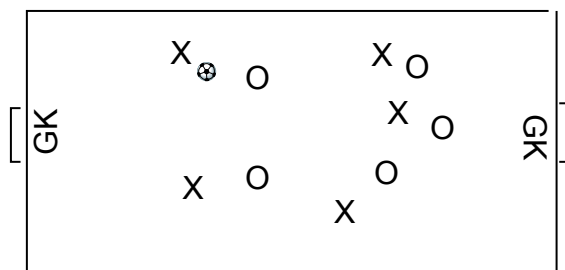

1/2 field scrimmage 5 v 5 on full size goals.

With enough players rotate teams every 3 minutes.

Emphasize running and passing into space, 1v1 near goals followed by shots.

### Coaching Points/Progression

1. To stimulate competition amongst teams, set up three teams and play a round robin tournament. Have the two teams with the best records play a "Final".
  2. Consider making up the teams in a couple of different ways:
    - a. defenders together, midfielders, and forwards.
    - b. one team with starting defenders and midfielders, the second with starting midfielders and forwards, the third with substitutes.
- No matter which way you go, stimulate competition by challenging units to beat the others.
3. This game will have lots of space for runs and good passes, so teams should not bog themselves down with wasteful dribbles.
  4. Add players to the teams as you see fit, even considering giving one team more players than the others.

### Coach's Notes



## Scrimmage # 9: 6+GK v 6+GK on 2 Goals - 1/2 Field

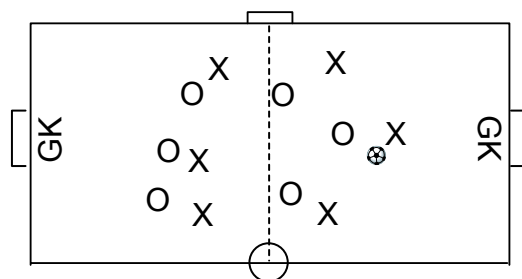

1. Play across 1/2 field 6 v 6 on full size goals.
2. Every player of attacking team must be in opponent's half before they can score.
3. When attacking team loses ball, every player must run to mark their player goalside.
4. Emphasize communication to cover attackers

### Coaching Points/Progression

1. There are no off-sides in this drill, therefore attacking players can "stretch" the field by making runs into the opposing half.
2. Quick passing into the opponents half is encouraged. The last player of the attacking team crossing the center field line must let his team mates know so that they can score.
3. This drill forces defenders to move out of their defensive zone quickly.
4. After change of possession, attackers need to transition to be goal side of the now attacking players as quickly as possible.
5. Make up teams according to your system of play and add or subtract palyers as required.

### Coach's Notes



## Scrimmage # 10: 3 v 3 + N on 4 Goals with GK

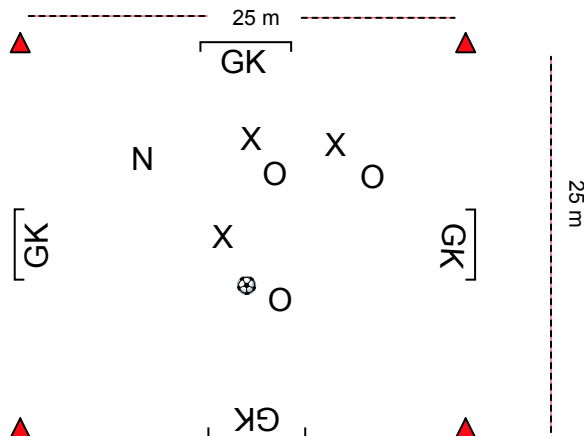

1. 3 v.3 + N playing on opposite goals w. GK. (X plays east/west; O plays north/south)
2. 3 minute games, rotate players through GK & N positions.
3. Neutral player plays with team in possession

### Coaching Points/Progression

1. The team in possession of the ball plays a 4v3 using the neutral player (N).
2. Defenders need to challenge player with ball and then cover other attackers to intercept passes.
3. Attackers, and especially the neutral players, must make runs to get into space to receive a pass.
4. Remind players that they can reverse direction and attack the goal behind them. That option should lead defenders to possibly have a player goalside of each goal they are defending.
5. as soon as defenders win the ball, they attack the goals changing direction. Attackers must now defend and get in position to defend their goals. Quick thinking will be trained.

### Coach's Notes